

AirMax[®] High Speed Backplane Connector System Family

The AirMax[®] family of connectors address the industry needs for high bandwidth applications requiring a scalable migration path to 25Gb/s data rate.

See how we can help you create a more efficient and cost-effective solution.

CONTENT PAGE

▶ AirMax® Product Family Overview & Comparison	2
▶ AirMax VSe® 25Gb/s	5
• Backplane Application	8
• Coplanar Application	10
▶ AirMax VS2® 20Gb/s	11
• Backplane Application	14
• Coplanar Application	16
• 2 Pair	17
▶ AirMax VS® 12.5Gb/s	19
• Backplane Application	23
• Coplanar Application	25
• Mezzanine Application	27
• 85Ω	31
▶ AirMax® Industry Applications	35
• CompactPCI®	35
• Storage Bridge Bay	39
▶ AirMax® High Speed Cable Assembly	43
▶ Power Connector Modules	45
▶ Mechanical Guidance Modules	49
▶ Insertion and Removal Tooling	51

AirMax® FAMILY COMPARISON

Product Family	Connector Application	Speed Performance	Signal via diameter (Finished Hole)	Mating Interface
<p>AirMax VSe®</p>	<ul style="list-style-type: none"> • Traditional Mother-Daughter Board • Coplanar • Midplane 	25Gb/s	0.4mm	AirMax VSe®, VS2® and VS® all share the same mating interface that enables scalable migration path, backward and forward mating compatibility
<p>AirMax VS2®</p>	<ul style="list-style-type: none"> • Traditional Mother-Daughter Board • Coplanar • Midplane 	20Gb/s	0.5mm & 0.4mm	
<p>AirMax VS®</p> <p>(Traditional)</p>	<ul style="list-style-type: none"> • Traditional Mother-Daughter Board • Coplanar • Midplane • Orthogonal Midplane 	12.5Gb/s	0.5mm	
<p>AirMax VS® SBB</p> <p>(Inverted)</p>	<ul style="list-style-type: none"> • Inverse Gender (Mother-Daughter Board) • Coplanar • Midplane • Orthogonal Midplane 	12.5Gb/s	0.5mm	

AirMax VSe® extends system performance to 25Gb/s by utilizing an innovative ECB (Electrical Conductive Bar). Bifurcated contact beams in the receptacle mating interface delivers proven reliability with two points of contact to the header pin.

AirMax VS2® extends system performance to 20Gb/s in a mechanically robust connector system. Bifurcated contact beams in the receptacle mating interface delivers proven reliability with two points of contact to the header pin.

AirMax VS® is the industry’s first air dielectric high speed connector system. The receptacle’s dual beam contact system enables reliable opposing beam contact mating.

APPLICATIONS



Communications

- Routers
- Switches
- Networking
- Access
- Transport
- Wireless



Data

- Servers
- Storage Systems



Industrial

- Industrial
- Medical
- Test & Measurement

INDUSTRY STANDARD SPECIFICATIONS

Standard Specifications	AirMax VSe®	AirMax VS2®	AirMax VS®
PCIe Gen1 2.5G	●	●	●
PCIe Gen2 5G	●	●	●
PCIe Gen3 8G	●	●	●
PCIe Gen4 16G	●	●	
Compact PCI Serial 12.5G			●
SAS1.1 3G	●	●	●
SAS2.1 6G	●	●	●
SAS3.0 12G	●	●	●
SAS4.0 24G	●		
SATA Revision 1.x 1.5G	●	●	●
SATA Revision 2.x 3G	●	●	●
SATA Revision 3.x 6G	●	●	●
SBB1.0 3G	●	●	●
SBB2.1 6G	●	●	●
SSI Modular Blade Server 12.5G	●	●	●
IEEE802.3ap/ba 10G	●	●	
IEEE802.3bj 25G	●		
OIF LR 25G	●		
QPI 8G (850hm only)			●

PRODUCT OFFERING SUMMARY

Application	AirMax VSe®			AirMax VS2®				AirMax VS®		
	3pair	4pair	5pair	2pair	3pair	4pair	5pair	3pair	4pair	5pair
Traditional Mother–Daughter, 100Ω	●	●	●	●	●	●	●	●	●	●
Inverse Mother–Daughter, 100Ω	●	●	●		●	●	●	●	●	●
Coplanar, 100Ω	●	●	●		●	●	●	●	●	●
Storage Bridge Bay, 100Ω					●			●		
Compact PCI, 100Ω									●	
Traditional Mother–Daughter, 85Ω								●		●
Orthogonal Midplane									●	
High Speed I/O Cable Assembly									●	
Mezzanine, 100Ω								●	●	●
Power Modules	●	●	●	●	●	●	●	●	●	●
Mechanical Guidance Modules	●	●	●	●	●	●	●	●	●	●

AirMax VSe[®] 25Gb/s BACKPLANE CONNECTOR SYSTEM

Cost optimized, 100Ω performance system

AirMax VSe[®] connectors address the industry needs for high bandwidth applications requiring a scalable migration path to 25Gb/s data rate. AirMax[®] technology delivers signal densities up to 63.5 differential pairs per inch when using a 5-pair connector system.

- Cost optimized, innovative edge-coupled design requires no internal ground shield between columns
- The air dielectric between conductors results in low insertion loss and low crosstalk, minimizing channel performance variations across every differential pair
- Backward mating compatible interface to AirMax VS[®] and VS2[®] with minimal changes to the connector footprint
- Supports both traditional and inverted mother-daughter board, midplane and coplanar applications
- Flexibility to assign contacts to differential or single-ended signals or low-level power within a module

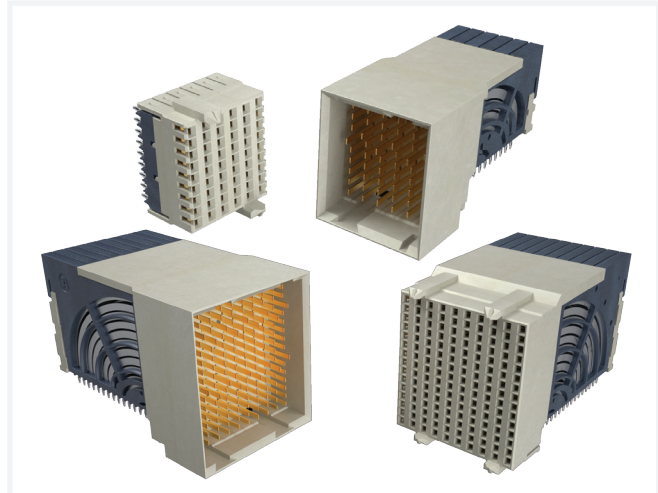

TARGET MARKETS



FEATURES

- Provides a scalable migration path to 25Gb/s per differential pair
- Innovative shieldless edge-coupling technology and air dielectric between adjacent conductors
- Grounds can be assigned to low speed signals
- Backward mating compatible interface with AirMax VS2[®] and AirMax VS[®]
- Modular, hard metric connector design
- No interleaving shields
- Designed to meet Telcordia GR-1217-CORE specifications

BENEFITS

- Scalable system architecture without costly redesign
- Superior electrical performance delivers low insertion loss and low crosstalk
- Allows mixing of differential pair signals, single ended signals, power and control lines within standard VSe connector module
- Maximizes pin assignment flexibility
- Enables easy migration path from previous generation systems
- 2.0mm pitch for high density application
- 3.0mm pitch enables quad routing and lower PCB cost
- Reduces connector cost, weight and PCB routing complexity
- Industry standard specification compliance
- High level of product performance and reliability

AirMax VSe® APPLICATION OVERVIEW

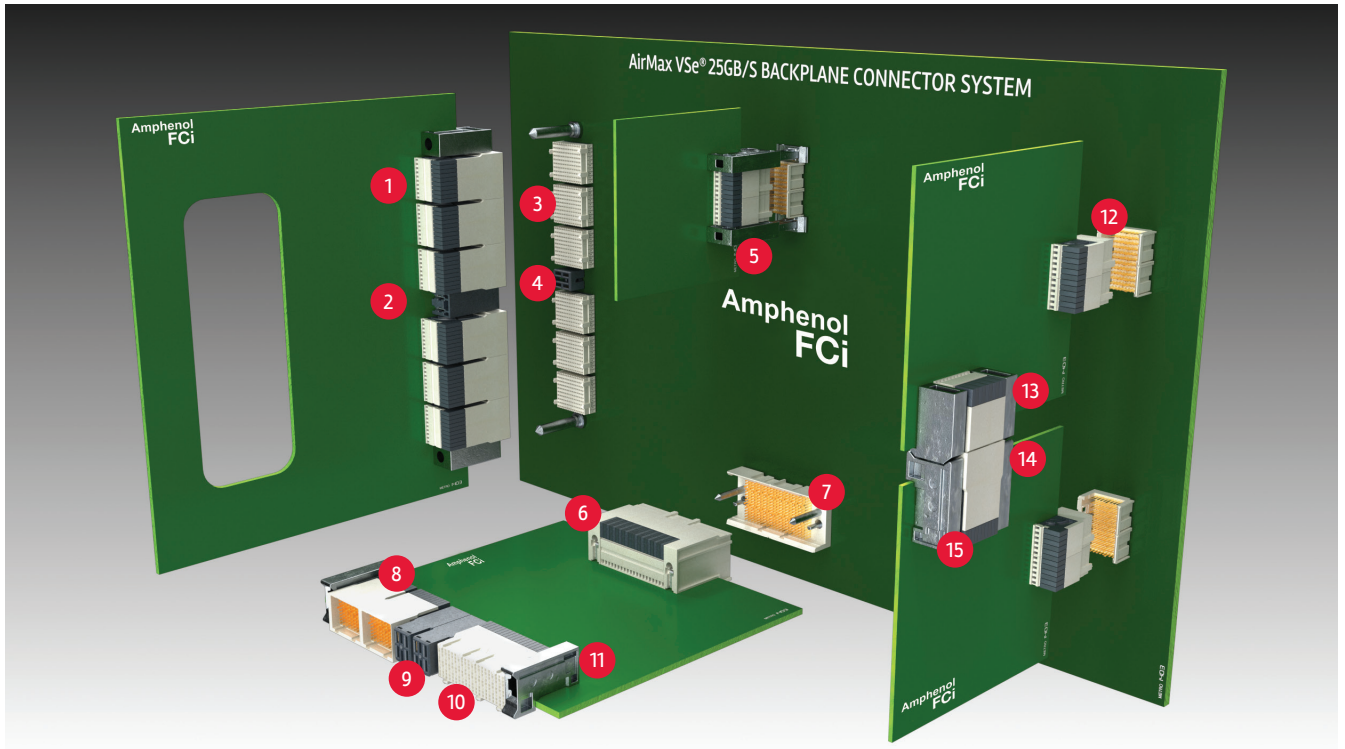

LEGEND

- | | | |
|--|---|--|
| 1 AirMax VSe® Inverse Gender – Right Angle Header | 6 AirMax VSe® Traditional Mother-Daughter Connector – Right Angle Receptacle Integrated Guide | 11 Mechanical Guidance Module |
| 2 AirMax® Power Connector Modules | 7 AirMax VSe® Traditional Mother-Daughter Connector – Vertical Header Integrated Guide | 12 AirMax VSe® Traditional Mother-Daughter Connector – No Guides |
| 3 AirMax VSe® Inverse Gender – Vertical Receptacle | 8 AirMax VSe® – Right Angle Header | 13 AirMax VSe® Coplanar Connector – Right Angle Header |
| 4 AirMax® Power Connector | 9 AirMax® Power Connector Modules | 14 Mechanical Guidance Module |
| 5 Mechanical Guidance Module | 10 AirMax VSe® – Right Angle Receptacle | 15 AirMax VSe® Coplanar Connector – Right Angle Receptacle |

AirMax VSe® 25Gb/s Traditional Mother Daughter Board Connectors – Backplane Header with Right Angle Receptacle on Daughter Card	AirMax VSe® 25Gb/s Inverse Gender – Backplane Receptacle with Right Angle Header on Daughter Card	AirMax VSe® 25Gb/s Coplanar	Mechanical Guidance Modules	AirMax® Power Connector Modules

TECHNICAL INFORMATION

SIGNAL INTEGRITY PERFORMANCE

**AirMax VSe® VH-RAR 4pr 2mm-
Power-Summed Crosstalk**

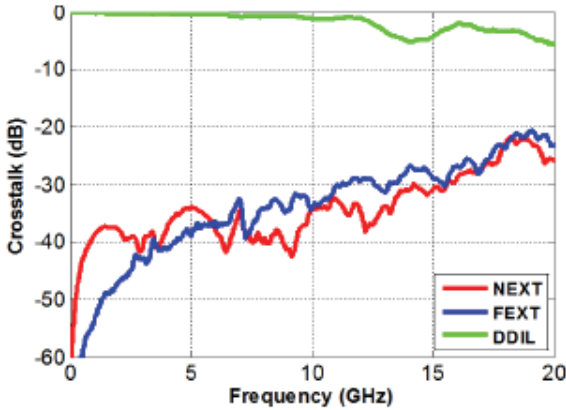

ELECTRICAL PERFORMANCE

- Contact Resistance: ≤60 mΩ initial in backplane application, ≤120 mΩ initial in coplanar application
- Current Rating (with ≤30°C temperature rise above ambient): 0.5 A/contact with all contacts powered
- Air dielectric provides lowest-possible insertion loss
- Optimized for lower crosstalk
- Reduced-resonance design
- Impedance: 100Ω

MECHANICAL PERFORMANCE

- Durability: 200 cycles
- Mating Force: 0.50N max./contact
- Unmating Force: 0.15N min./contact
- Average Compliant Pin Insertion Force/pin:
 - 0.4mm PCB hole: 15N max.
 - 0.5mm PCB hole: 30N max.
- Average Compliant Retention Force:
 - 0.4mm PCB hole: 3.6 N min.
 - 0.5mm PCB hole: 4.5N min.

APPROVALS AND CERTIFICATIONS

- Telcordia GR-1217-CORE Central Office qualification passed
- UL approved: UL File E66906

SPECIFICATIONS

- Product Specification: GS-12-0956
- Application Specification: GS-20-0305

PACKAGING

- Trays or Tubes

MATERIALS

- Contacts: High performance Copper Alloy
- Contact Finish:
 - Performance-based plating at separable interface (Telcordia GR-1217-CORE Central Office)
 - Tin over Nickel on press-fit tails
 - Tin-lead option
- Housings: High Performance Thermoplastic, UL94-V0

CONNECTOR DENSITY

Minimum Card Slot Spacing (mm)	Column Pitch (mm)	Dimension A (mm)	Differential Pairs			Contacts		
			Per Column	Linear Density		Per Column	Linear Density	
				Per inch	Per cm		Per inch	Per cm
25	2	20.1	5	63.5	25	15	190.5	75
25	3	20.1	5	42.3	16.7	15	127	50
20	2	15.9	4	50.8	20	12	152.4	60
20	3	15.9	4	33.9	13.3	12	101.6	40
17	2	11.7	3	38.1	15	9	114.3	45
17	3	11.7	3	25.4	10	9	76.2	30

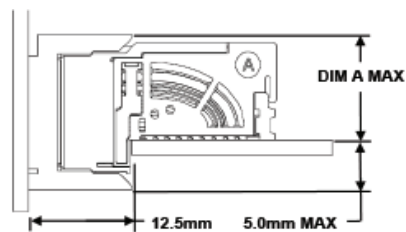

Dimension		Example 1	Example 2
Column pitch	CP	2000	2000
Trace	W	150	203
Space	S	127	297
Pad	P	800	814
Antipad	Wa	1500	1145
Total Routing Width	TRW	427	703
Annular Ring	Wr	200	207
Clearance Drill -Trace	Cd-t	536.5	399.0
Clearance Pad-Trace	Cp-t	386.5	241.0
Clearance Antipad-Trace	Ca-t	36.5	76.0

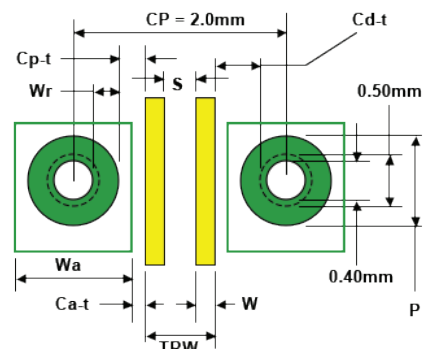

MOTHER-DAUGHTER BOARD APPLICATION

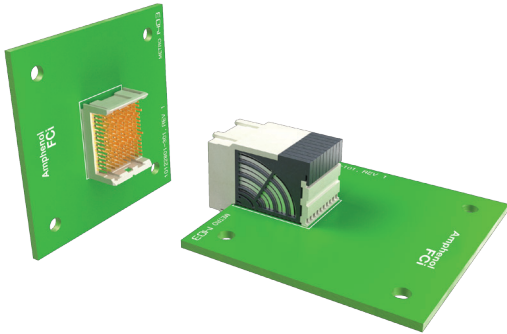

AirMax VSe® TRADITIONAL MOTHER-DAUGHTER BOARD CONNECTORS – BACKPLANE HEADER WITH RIGHT ANGLE RECEPTACLE ON DAUGHTER CARD: NO GUIDE

AirMax VSe® Traditional Mother – Daughter Board					
Product Variation			No Guide Pin – 2.0mm Column Pitch		
Pairs	Columns	Differential Pairs	Mating Connector System		Differential Impedance
			Vertical Header 2 Wall	Right Angle Receptacle	
3	6	18	10116601-101LF	10115910-101LF	100Ω
	8	24	10129146-101LF	10122263-101LF	
	10	30	10130519-101LF	10124432-101LF	
4	6	24	10130521-101LF	10130562-101LF	100Ω
	8	32	10130531-101LF	10130563-101LF	
	10	40	10117992-101LF	10115911-101LF	
	16	64	10118260-101LF	10115912-101LF	
5	6	30	10135296-101LF	10135300-101LF	100Ω
	8	40	10130530-101LF	10130564-101LF	
	10	50	10116602-101LF	10115913-101LF	

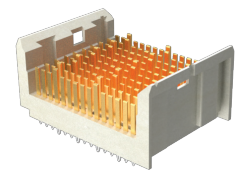

**Vertical Header
(No Guide)**

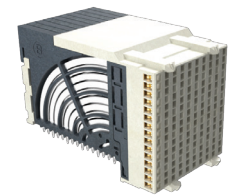

**Right Angle Receptacle
(No Guide)**

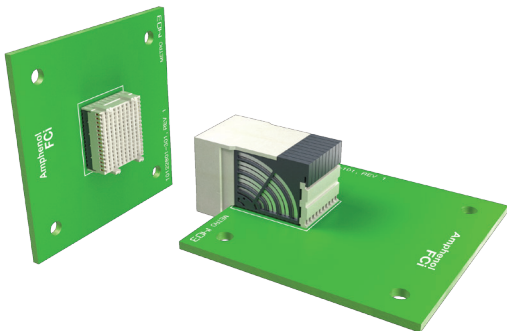

AirMax VSe® INVERSE GENDER MOTHER-DAUGHTER BOARD CONNECTORS – BACKPLANE RECEPTACLE WITH RIGHT ANGLE HEADER ON DAUGHTER CARD: NO GUIDE

AirMax VSe® Inverse Mother – Daughter Board					
Product Variation			No Guide Pin – 2.0mm Column Pitch		
Pairs	Columns	Differential Pairs	Mating Connector System		Differential Impedance
			Vertical Header 2 Wall	Right Angle Receptacle	
3	6	18	10120757-101LF	10119886-101LF	100Ω
	8	24	10120758-101LF	10122919-101LF	
	10	30	10120759-101LF	10124451-101LF	
4	6	24	10120764-101LF	10130569-101LF	100Ω
	8	32	10120765-101LF	10124864-101LF	
	10	40	10120766-101LF	10120001-101LF	
5	6	30	10135634-101LF	10135621-101LF	100Ω
	8	40	10120771-101LF	10130570-101LF	
	10	50	10120773-101LF	10120009-101LF	

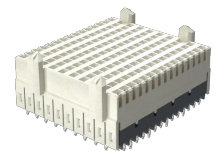

**Vertical Receptacle
(No Guide)**

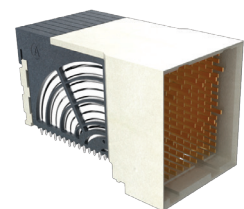

**Right Angle Header
(No Guide)**

MOTHER-DAUGHTER BOARD APPLICATION

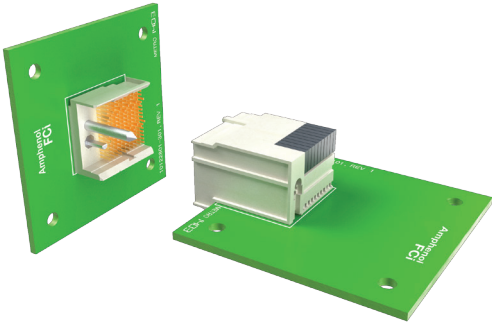

AirMax VSe® TRADITIONAL MOTHER-DAUGHTER BOARD CONNECTORS – BACKPLANE HEADER WITH RIGHT ANGLE RECEPTACLE ON DAUGHTER CARD: LEFT GUIDE PIN

AirMax VSe® Traditional Mother – Daughter Board					
Product Variation			Left Guide Pin – 2.0mm Column Pitch		
Pairs	Columns	Differential Pairs	Mating Connector System		Differential Impedance
			Vertical Header 2 Wall	Right Angle Receptacle	
3	6	18	10135260-10ALF	10135262-10ALF	100Ω
	8	24	10135265-10ALF	10135268-10ALF	
	10	30	10135271-10ALF	10135274-10ALF	
4	6	24	10135278-10ALF	10135281-10ALF	100Ω
	8	32	10135284-10ALF	10135287-10ALF	
	10	40	10135290-10ALF	10135293-10ALF	
5	6	30	10135305-10ALF	10135308-10ALF	100Ω
	8	40	10135311-10ALF	10135314-10ALF	
	10	50	10135317-10ALF	10135320-10ALF	

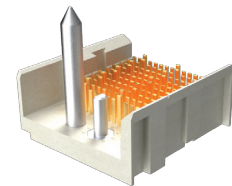

**Vertical Header
(Left Guide)**

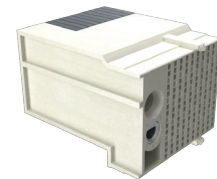

**Right Angle Receptacle
(Left Guide)**

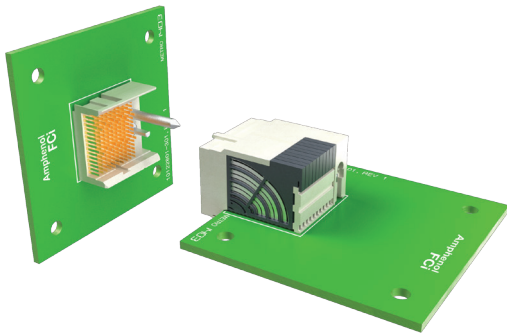

AirMax VSe® TRADITIONAL MOTHER-DAUGHTER BOARD CONNECTORS – BACKPLANE RECEPTACLE WITH RIGHT ANGLE HEADER ON DAUGHTER CARD: RIGHT GUIDE PIN

AirMax VSe® Traditional Mother – Daughter Board					
Product Variation			Right Guide Pin – 2.0mm Column Pitch		
Pairs	Columns	Differential Pairs	Mating Connector System		Differential Impedance
			Vertical Header 2 Wall	Right Angle Receptacle	
3	6	18	10135260-10PLF	10135262-10PLF	100Ω
	8	24	10135265-10PLF	10135268-10PLF	
	10	30	10135271-10PLF	10135274-10PLF	
4	6	24	10135278-10PLF	10135281-10PLF	100Ω
	8	32	10135284-10PLF	10135287-10PLF	
	10	40	10135290-10PLF	10135293-10PLF	
5	6	30	10135305-10PLF	10135308-10PLF	100Ω
	8	40	10135311-10PLF	10135314-10PLF	
	10	50	10135317-10PLF	10135320-10PLF	

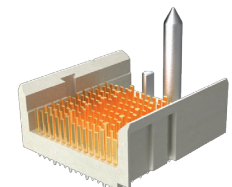

**Vertical Receptacle
(Right Guide)**

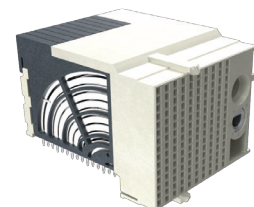

**Right Angle Header
(Right Guide)**

COPLANAR APPLICATION

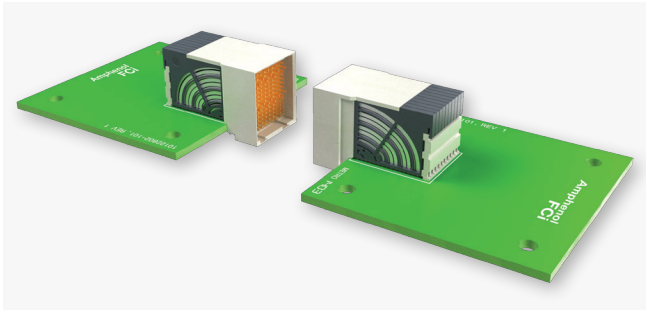

**AirMax VSe® COPLANAR CONNECTORS
- TRADITIONAL**

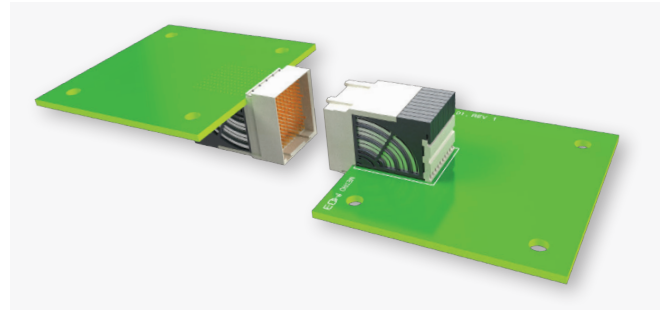

**AirMax VSe® COPLANAR CONNECTORS
- INVERSE**

AirMax VSe® Inverse Mother – Daughter Board					
Product Variation			No Guide Pin – 2.0mm Column Pitch		
Pairs	Columns	Differential Pairs	Mating Connector System		
			Vertical Header 2 Wall	Right Angle Receptacle	Differential Impedance
3	6	18	10115910-101LF	10119886-101LF	100Ω
	8	24	10122263-101LF	10122919-101LF	
	10	30	10124432-101LF	10124451-101LF	
4	6	24	10130562-101LF	10130569-101LF	100Ω
	8	32	10130563-101LF	10124864-101LF	
	10	40	10115911-101LF	10120001-101LF	
5	6	30	10135300-101LF	10135621-101LF	100Ω
	8	40	10130564-101LF	10130570-101LF	
	10	50	10115913-101LF	10120009-101LF	

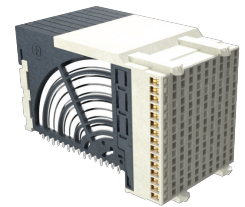

Right Angle Receptacle

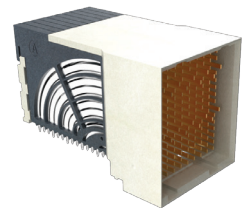

Right Angle Header

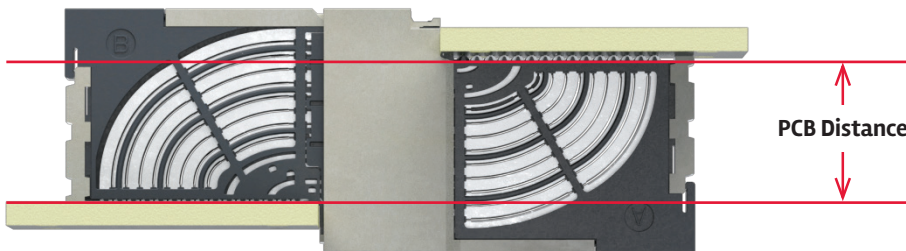

Inverse Coplanar Connectors	
Connector Type	PCB Distance
3Pair	6.6mm
4Pair	10.8mm
5Pair	15.0mm

AirMax VS2® 20Gb/s BACKPLANE CONNECTOR SYSTEM

Cost optimized, high performance system



AirMax VS2® connectors address the industry needs for high bandwidth applications requiring a scalable migration path to 20Gb/s data rate. AirMax® technology delivers signal densities up to 63.5 differential pairs per inch when using a 5-pair connector system.

- Cost optimized, innovative edge-coupled design requires no internal ground shield between columns
- The air dielectric between conductors results in low insertion loss and low crosstalk, minimizing channel performance variations across every differential pair
- Backward mating compatible interface to AirMax VS® and VS2® with minimal changes to the connector footprint
- Supports both traditional and inverted mother-daughter board, midplane and coplanar applications
- Flexibility to assign contacts to differential or single-ended signals or low-level power within a module



FEATURES

- Provides a scalable migration path to 20Gb/s per differential pair
- Innovative shieldless edge-coupling technology and air dielectric between adjacent conductors
- Grounds can be assigned to low speed signals
- Backward mating compatible interface with AirMax VS® and forward mating compatible with AirMax VSe®
- Modular, hard metric connector design
- No interleaving shields
- Designed to meet Telcordia GR-1217-CORE specifications

BENEFITS

- Scalable system architecture without costly redesign
- Superior electrical performance delivers low insertion loss and low crosstalk
- Allows mixing of differential pair signals, single ended signals, power and control lines within standard VSe connector module
- Maximizes pin assignment flexibility
- Enables easy migration path
- 2.0mm pitch for high density application
- 3.0mm pitch enables quad routing and lower PCB cost
- Reduces connector cost, weight and PCB routing complexity
- Industry standard specification compliance
- High level of product performance and reliability

AirMax VS2® APPLICATION OVERVIEW

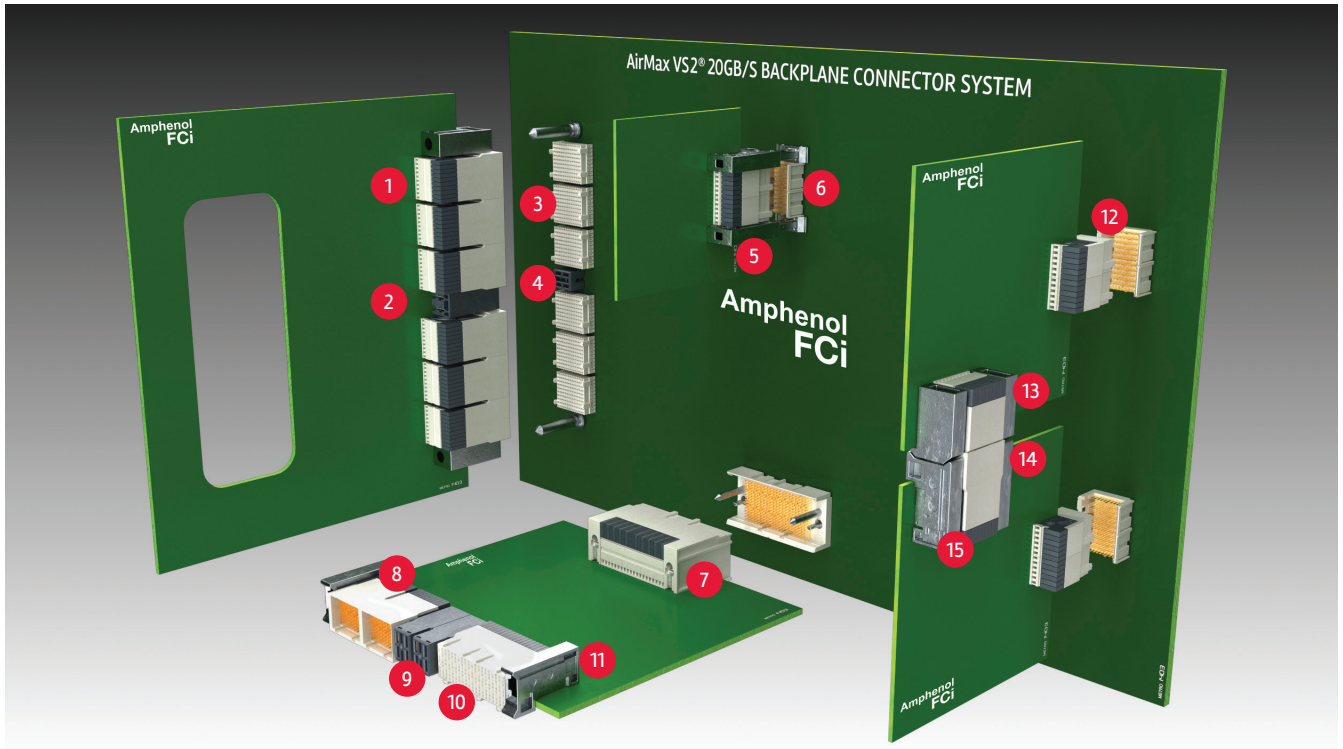

LEGEND

- | | | |
|--|---|--|
| 1 AirMax VS2® Inverse Gender – Right Angle Header | 6 AirMax VS2® Traditional Mother–Daughter Connector – Vertical Header | 11 Mechanical Guidance Module |
| 2 AirMax® Power Connector Modules | 7 AirMax VS2® Traditional Mother–Daughter Connector – Right Angle Receptacle Integrated Guide | 12 AirMax VS2® Traditional Mother–Daughter Connector – No Guides |
| 3 AirMax VS2® Inverse Gender – Vertical Receptacle | 8 AirMax VS2® – Right Angle Header | 13 AirMax VS2® Coplanar Connector – Right Angle Header |
| 4 AirMax® Power Connector | 9 AirMax® Power Connector Modules | 14 Mechanical Guidance Module |
| 5 Mechanical Guidance Module | 10 AirMax VS2® – Right Angle Receptacle | 15 AirMax VS2® Coplanar Connector – Right Angle Receptacle |

AirMax VS2® 20Gb/s Traditional Mother Daughter Board Connectors – Backpanel Header with Right Angle Receptacle on Daughter Card	AirMax VS2® 20Gb/s Inverse Gender – Backplane Receptacle with Right Angle Header on Daughter Card	AirMax VS2® 20Gb/s Coplanar	Mechanical Guidance Modules	AirMax® Power Connector Modules

TECHNICAL INFORMATION

SIGNAL INTEGRITY PERFORMANCE

**AirMax VS2® VH-RAR 4pr 2mm-
Power-Summed Crosstalk**

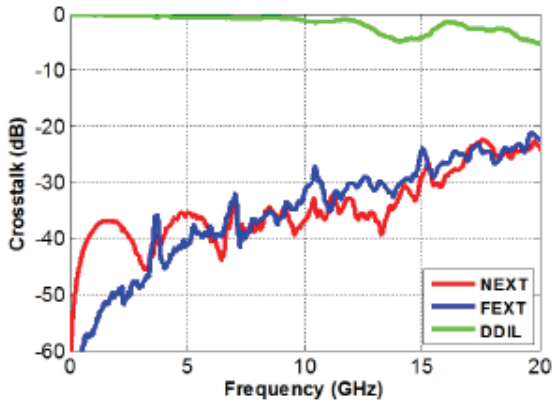

ELECTRICAL PERFORMANCE

- Contact Resistance: $\leq 60m\Omega$ initial in backplane application, $\leq 120 m\Omega$ I initial in coplanar application
- Current Rating (with $\leq 30^\circ C$ temperature rise above ambient): 0.5 A/contact with all contacts powered
- Air dielectric provides lowest-possible insertion loss
- Optimized for lower crosstalk
- Reduced resonance design

MECHANICAL PERFORMANCE

- Durability: 200 cycles
- Mating Force: 0.50N max./contact
- Unmating Force: 0.15N min./contact
- Average Compliant Pin Insertion Force/pin:
 - 0.4mm PCB hole: 15N max.
 - 0.5mm PCB hole: 30N max.
- Average Compliant Retention Force:
 - 0.4mm PCB hole: 3.6 N min.
 - 0.5mm PCB hole: 4.5N min.

APPROVALS AND CERTIFICATIONS

- Telcordia GR-1217-CORE Central Office qualification passed
- UL approved: UL File E66906

SPECIFICATIONS

- Product Specification: GS-12-0956
- Application Specification: GS-20-0305

PACKAGING

- Trays or Tubes

MATERIALS

- Contacts: High performance Copper Alloy
- Contact Finish:
 - Performance-based plating at separable interface (Telcordia GR-1217-CORE Central Office)
 - Tin over Nickel on press-fit tails
 - Tin-lead option
- Housings: High Performance Thermoplastic, 94-V0

CONNECTOR DENSITY

Minimum Card Slot Spacing (mm)	Column Pitch (mm)	Dimension A (mm)	Differential Pairs			Contacts		
			Per Column	Linear Density		Per Column	Linear Density	
				Per inch	Per cm		Per inch	Per cm
25	2	20.1	5	63.5	25	15	190.5	75
25	3	20.1	5	42.3	16.7	15	127	50
20	2	15.9	4	50.8	20	12	152.4	60
20	3	15.9	4	33.9	13.3	12	101.6	40
17	2	11.7	3	38.1	15	9	114.3	45
17	3	11.7	3	25.4	10	9	76.2	30

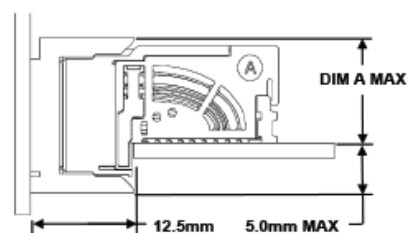

Dimension	Example 1	Example 2	
Column pitch	CP	2000	2000
Trace	W	150	203
Space	S	127	297
Pad	P	800	814
Antipad	Wa	1500	1145
Total Routing Width	TRW	427	703
Annular Ring	Wr	200	207
Clearance Drill -Trace	Cd-t	536.5	399.0
Clearance Pad-Trace	Cp-t	386.5	241.0
Clearance Antipad-Trace	Ca-t	36.5	76.0

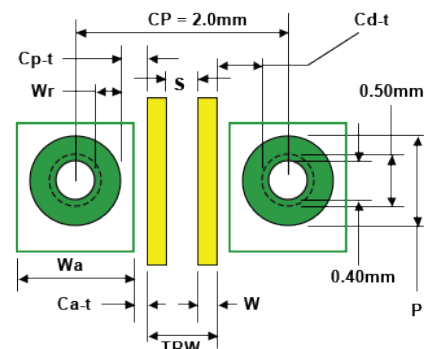

MOTHER-DAUGHTER BOARD APPLICATION

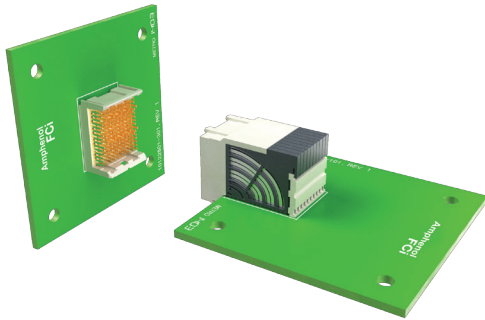

AirMax VS2® TRADITIONAL MOTHER-DAUGHTER BOARD CONNECTORS – BACKPLANE HEADER WITH RIGHT ANGLE RECEPTACLE ON DAUGHTER CARD: NO GUIDE

AirMAX VS2® Traditional Mother – Daughter Board					
Product Variation			No Guide Pin – 2.0mm Column Pitch		
Pairs	Columns	Differential Pairs	Mating Connector System		
			Vertical Header 2 Wall	Right Angle Receptacle	Differential Impedance
3	6	18	10116601-101LF	10136585-101LF	100Ω
	8	24	10129146-101LF	10136586-101LF	
	10	30	10130519-101LF	10136587-101LF	
4	6	24	10130521-101LF	10133025-101LF	100Ω
	8	32	10130531-101LF	10133027-101LF	
	10	40	10117992-101LF	10135275-101LF	
	16	64	10118260-101LF	10136588-101LF	
5	6	30	10135296-101LF	10135299-101LF	100Ω
	8	40	10130530-101LF	10135301-101LF	
	10	50	10116602-101LF	10135302-101LF	

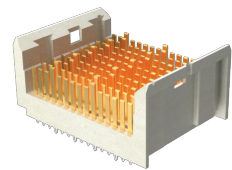

**Vertical Header
(No Guide)**

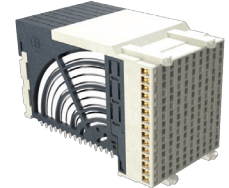

**Right Angle Receptacle
(No Guide)**

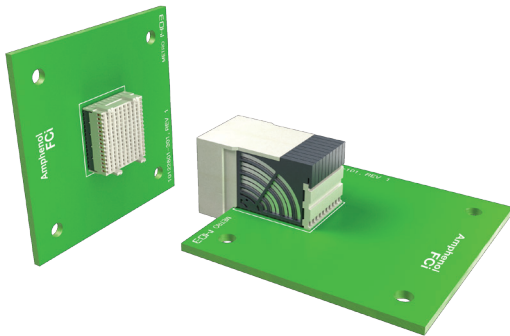

AirMax VS2® INVERSE GENDER MOTHER-DAUGHTER BOARD CONNECTORS – BACKPLANE RECEPTACLE WITH RIGHT ANGLE HEADER ON DAUGHTER CARD: NO GUIDE

AirMax VS2® Inverse Mother – Daughter Board					
Product Variation			No Guide Pin – 2.0mm Column Pitch		
Pairs	Columns	Differential Pairs	Mating Connector System		
			Vertical Header 2 Wall	Right Angle Header 4 Wall	Differential Impedance
3	6	18	10130665-102LF	10124149-102LF	100Ω
	8	24	10128101-102LF	10124755-102LF	
	10	30	10130666-102LF	10126918-102LF	
4	6	24	10130667-102LF	10130571-102LF	100Ω
	8	32	10130668-102LF	10130572-102LF	
	10	40	10130669-102LF	10124150-102LF	
5	8	40	10130670-102LF	10129940-102LF	100Ω
	10	50	10127982-102LF	10124151-102LF	

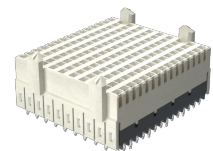

**Vertical Receptacle
(No Guide)**

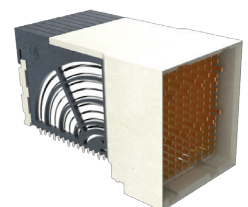

**Right Angle Header
(No Guide)**

MOTHER-DAUGHTER BOARD APPLICATION

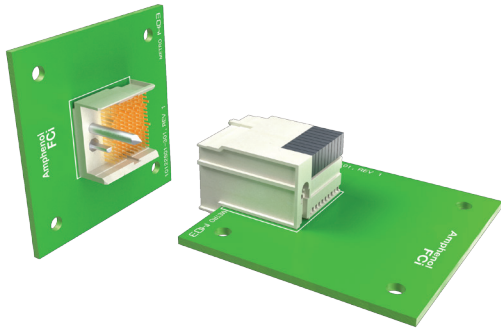

AirMax VS2® TRADITIONAL MOTHER-DAUGHTER BOARD CONNECTORS – BACKPLANE HEADER WITH RIGHT ANGLE RECEPTACLE ON DAUGHTER CARD: LEFT GUIDE PIN

AirMax VS2® Traditional Mother – Daughter Board					
Product Variation			Left Guide Pin – 2.0mm Column Pitch		
Pairs	Columns	Differential Pairs	Mating Connector System		
			Vertical Header 2 Wall	Right Angle Receptacle	Differential Impedance
3	6	18	10135260-10ALF	10135261-10ALF	100Ω
	8	24	10135265-10ALF	10135267-10ALF	
	10	30	10135271-10ALF	10135273-10ALF	
4	6	24	10135278-10ALF	10135280-10ALF	100Ω
	8	32	10135284-10ALF	10135286-10ALF	
	10	40	10135290-10ALF	10135292-10ALF	
5	6	30	10135305-10ALF	10135307-10ALF	100Ω
	8	40	10135311-10ALF	10135313-10ALF	
	10	50	10135317-10ALF	10135319-10ALF	

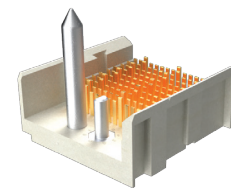

**Vertical Header
(Left Guide)**

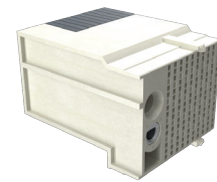

**Right Angle Receptacle
(Left Guide)**

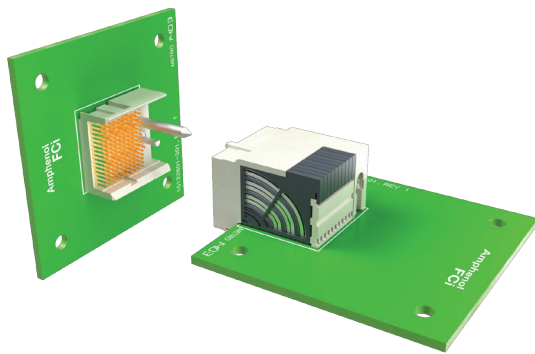

AirMax VS2® TRADITIONAL MOTHER-DAUGHTER BOARD CONNECTORS – BACKPLANE RECEPTACLE WITH RIGHT ANGLE HEADER ON DAUGHTER CARD: RIGHT GUIDE PIN

AirMax VS2® Traditional Mother – Daughter Board					
Product Variation			Right Guide Pin – 2.0mm Column Pitch		
Pairs	Columns	Differential Pairs	Mating Connector System		
			Vertical Header 2 Wall	Right Angle Receptacle	Differential Impedance
3	6	18	10135260-10PLF	10135261-10PLF	100Ω
	8	24	10135265-10PLF	10135267-10PLF	
	10	30	10135271-10PLF	10135273-10PLF	
4	6	24	10135278-10PLF	10135280-10PLF	100Ω
	8	32	10135284-10PLF	10135286-10PLF	
	10	40	10135290-10PLF	10135292-10PLF	
5	6	30	10135305-10PLF	10135307-10PLF	100Ω
	8	40	10135311-10PLF	10135313-10PLF	
	10	50	10135317-10PLF	10135319-10PLF	

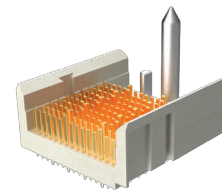

**Vertical Header
(Right Guide)**

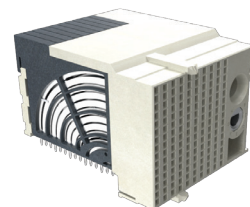

**Right Angle Header
(Right Guide)**

COPLANAR APPLICATION

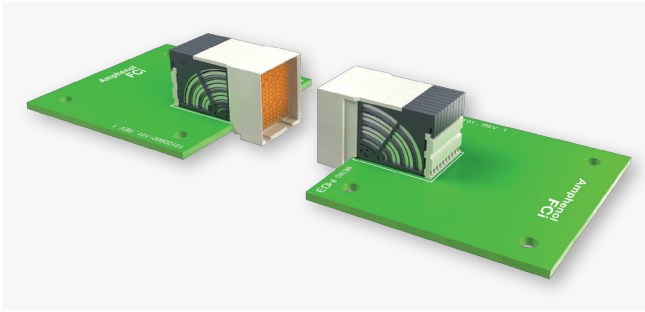

**AirMax VS2® COPLANAR CONNECTORS
– TRADITIONAL**

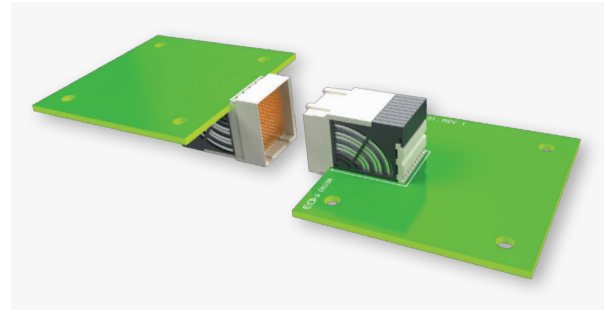

**AirMax VS2® COPLANAR CONNECTORS
– INVERSE**

AirMax VS2® Coplanar Board					
Product Variation			No Guide Pin – 2.0mm Column Pitch		
Pairs	Columns	Differential Pairs	Mating Connector System		
			Vertical Header 2 Wall	Right Angle Header 4 Wall	Differential Impedance
3	6	18	10136585-101LF	10136589-101LF	100Ω
	8	24	10136586-101LF	10136590-101LF	
	10	30	10136587-101LF	10136591-101LF	
4	6	24	10133025-101LF	10136592-101LF	100Ω
	8	32	10133027-101LF	10136593-101LF	
	10	40	10135275-101LF	10136594-101LF	
5	6	30	10135299-101LF	10136600-101LF	100Ω
	8	40	10135301-101LF	10136595-101LF	
	10	50	10135302-101LF	10136596-101LF	

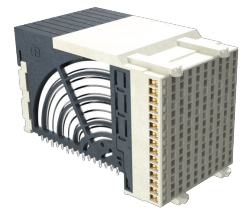

Right Angle Receptacle

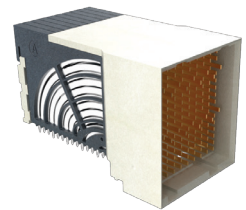

Right Angle Header

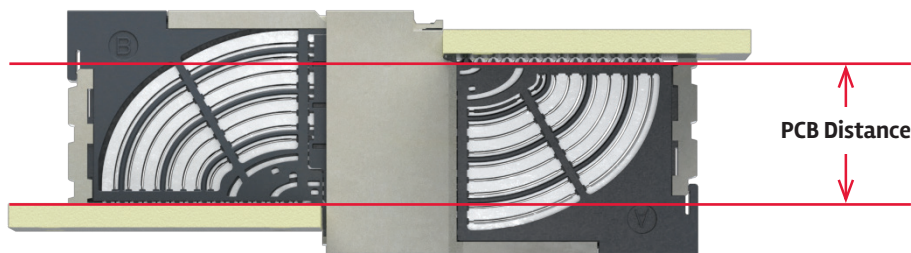

Inverse Coplanar Connectors	
Connector Type	PCB Distance
3Pair	6.6mm
4Pair	10.8mm
5Pair	15.0mm

AirMax VS2® 20Gb/s 2 PAIR BACKPLANE CONNECTOR SYSTEM

AirMax VS2® connectors use innovative edge-coupling and air dielectric between adjacent conductors to deliver low insertion loss and crosstalk. This technology enables low cost, high performance connectors that are a leading backplane interconnect solution for telecom, networking equipment, server, and storage applications.

- Space-saving 1.9mm column pitch
- Innovative edge-coupled design requires no internal ground shield between columns
- Low insertion loss and low crosstalk
- Shieldless open pin field design with no pre-assigned ground pins
- Suitable for a broad range of system architectures, including backplane and midplane applications



FEATURES

- 1.9mm column pitch
- Modular, hard metric connector design
- Innovative shieldless edge-coupling technology and air dielectric between adjacent conductors
- Grounds can be assigned to low speed signals

BENEFITS

- High density connector maximizes board real estate
- Adopted by multiple industry standard architectures
- Superior electrical performance delivers low insertion loss and low crosstalk
- Reduces cost
- Allows mixing of differential pair signals, single ended signals, power and control lines within standard connector module
- Maximizes pin assignment flexibility

▶ **AirMax VS2® 20Gb/s 2 PAIR
BACKPLANE CONNECTOR SYSTEM**

MOTHER-DAUGHTER BOARD APPLICATION

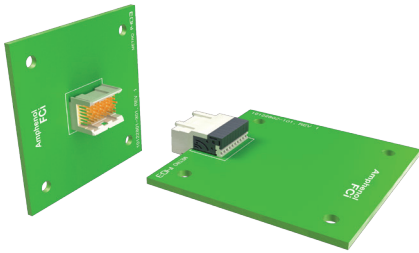

AirMax VS2® HIGH DENSITY TRADITIONAL MOTHER-DAUGHTER BOARD CONNECTORS – BACKPLANE HEADER WITH RIGHT ANGLE RECEPTACLE ON DAUGHTER CARD: NO GUIDE

AirMAX VS2® Traditional Mother – Daughter Board					
Product Variation			No Guide Pin – 1.9mm Column Pitch		
Pairs	Columns	Differential Pairs	Mating Connector System		
			Vertical Header 2 Wall	Right Angle Receptacle	Differential Impedance
2	6	12	10134944-101LF	10134922-101LF	100Ω
	8	16	10134941-101LF	10134947-101LF	
	10	20	10134930-101LF	10134955-101LF	

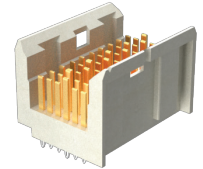

**Vertical Header
(No Guide)**

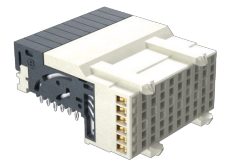

**Right Angle Receptacle
(No Guide)**

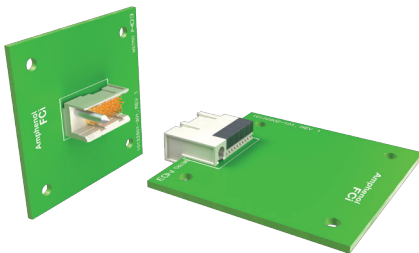

AirMax VS2® HIGH DENSITY TRADITIONAL MOTHER-DAUGHTER BOARD CONNECTORS – BACKPLANE HEADER WITH RIGHT ANGLE RECEPTACLE ON DAUGHTER CARD: LEFT GUIDE PIN

AirMAX VS2® Traditional Mother – Daughter Board					
Product Variation			Left Guide Pin – 1.9mm Column Pitch		
Pairs	Columns	Differential Pairs	Mating Connector System		
			Vertical Header 2 Wall	Right Angle Receptacle	Differential Impedance
2	6	12	10134918-101LF	10134924-101LF	100Ω
	8	16	10134966-101LF	10134962-101LF	
	10	20	10134932-101LF	10134957-101LF	

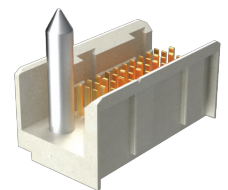

**Vertical Header
(Left Guide)**

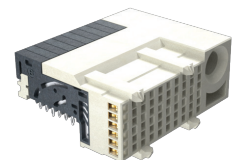

**Right Angle Receptacle
(Left Guide)**

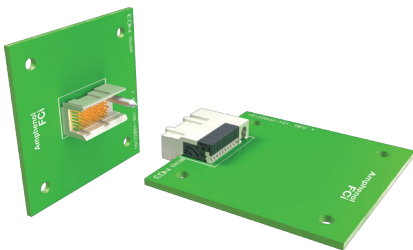

AirMax VS2® HIGH DENSITY TRADITIONAL MOTHER-DAUGHTER BOARD CONNECTORS – BACKPLANE HEADER WITH RIGHT ANGLE RECEPTACLE ON DAUGHTER CARD: RIGHT GUIDE PIN

AirMAX VS2® Traditional Mother – Daughter Board					
Product Variation			Right Guide Pin – 1.9mm Column Pitch		
Pairs	Columns	Differential Pairs	Mating Connector System		
			Vertical Header 2 Wall	Right Angle Receptacle	Differential Impedance
2	6	12	10134920-101LF	10134926-101LF	100Ω
	8	16	10134968-101LF	10134964-101LF	
	10	20	10134934-101LF	10134959-101LF	

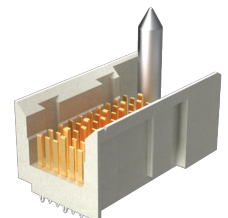

**Vertical Header
(Right Guide)**

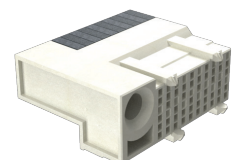

**Right Angle Receptacle
(Right Guide)**

AirMax VS[®] 12.5Gb/s BACKPLANE CONNECTOR SYSTEM

AirMax VS[®] connectors use innovative edge-coupling and air dielectric between adjacent conductors to deliver low insertion loss and crosstalk. This technology enables low cost, high performance connectors that are a leading backplane interconnect solution for telecom, networking equipment, server, and storage applications.

- Backward mating compatible interface to AirMax VS[®] and VS2[®] with minimal changes to the connector footprint
- The air dielectric between conductors results in low insertion loss and low crosstalk, minimizing channel performance variations across every differential pair
- Shieldless open pin field design with no pre-assigned ground pins provides the ultimate flexibility in board layout
- Suitable for a broad range of system architectures, including backplane, midplane, coplanar and mezzanine applications
- The mating-compatible interfaces and capability to preserve critical pin assignments can provide opportunities for cost savings as new or upgraded equipment is deployed

FEATURES

- Innovative shieldless edge-coupling technology and air dielectric between adjacent conductors
- Grounds can be assigned to low speed signals
- Forward mating compatible interface with AirMax VS2[®] and AirMax VSe[®]
- Modular, hard metric connector design
- No interleaving shields
- Designed to meet Telcordia GR-1217-CORE specifications
- Adopted by multiple industry standard architectures, including Storage Bridge Bay (SBB) and Compact PCI (CPCI) Serial

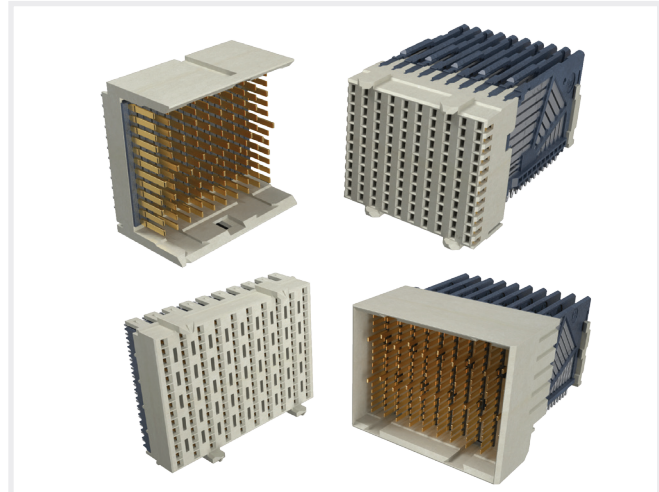

TARGET MARKETS



BENEFITS

- Superior electrical performance delivers low insertion loss and low crosstalk
- Allows mixing of differential pair signals, single ended signals, power and control lines within standard connector module
- Maximizes pin assignment flexibility
- Enables easy migration path to next generation systems
- 2.0mm pitch for high density application
- 3.0mm pitch enables quad routing and lower PCB cost
- Reduces connector cost, weight and PCB routing complexity
- Industry standard specification compliance
- High level of product performance and reliability
- Standard configurations and part numbers accelerate design and reduce risks

▶ **AirMax VS® 12.5Gb/s
BACKPLANE CONNECTOR SYSTEM**

AirMax VS® APPLICATION OVERVIEW

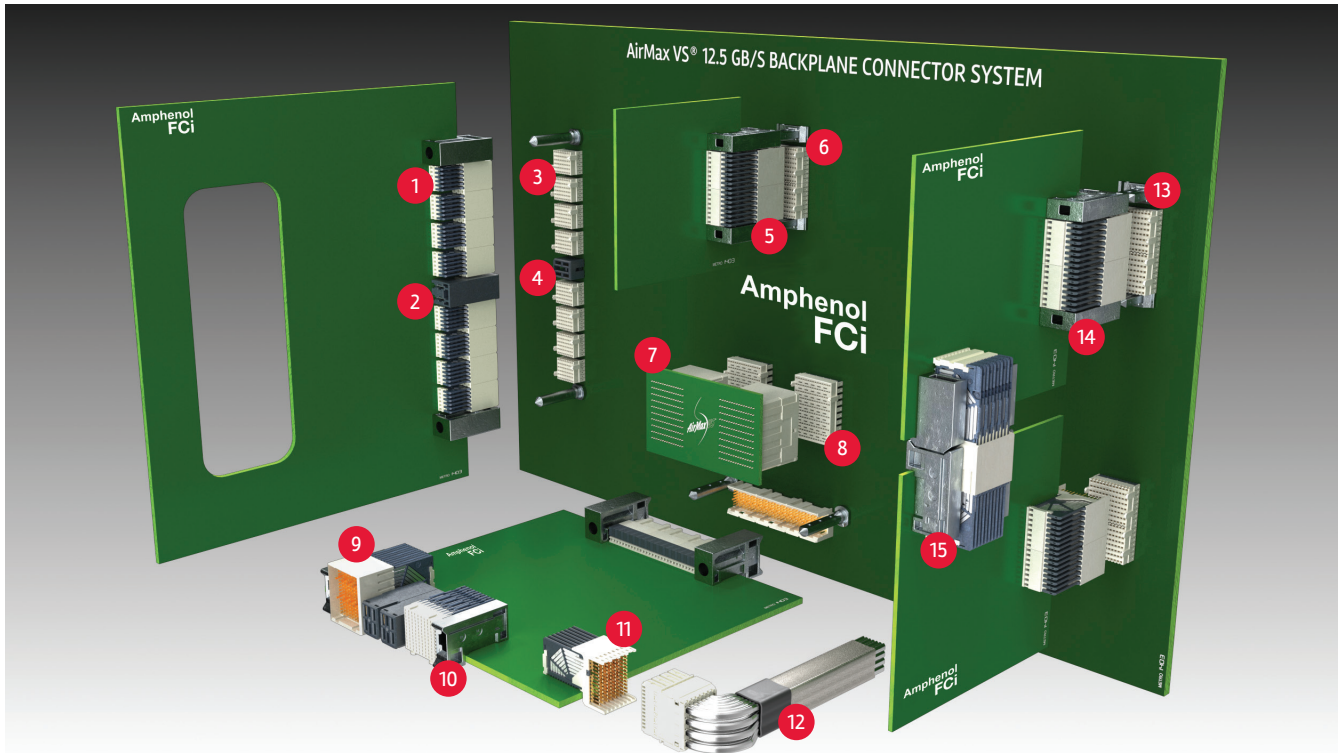

LEGEND

- | | | |
|--|---|---|
| 1 AirMax VS® Storage Bridge Bay (SBB) Connector Inverse Gender – Right Angle Header | 6 AirMax VS® CompactPCI Connector – Vertical Receptacle | 11 AirMax VS® Connector – Right Angle Header (2 wall) |
| 2 AirMax® Power Connector Modules | 7 AirMax® Mezzanine Connector – Vertical Header | 12 AirMax VS® IO Internal Cable Assembly |
| 3 AirMax VS® Storage Bridge Bay (SBB) Connector Inverse Gender – Vertical Receptacle | 8 AirMax® Mezzanine Connector – Vertical Receptacle | 13 AirMax VS® Connector – Vertical Receptacle |
| 4 AirMax® Power Connector | 9 AirMax VS® Connector I – Right Angle Header (4 wall) | 14 AirMax VS® Connector – Right Angle Header |
| 5 AirMax VS® CompactPCI Connector – Right Angle Header | 10 AirMax® Power Connector Modules | 15 Mechanical Guidance Module |

**AirMax VS® 12.5Gb/s
BACKPLANE CONNECTOR SYSTEM**

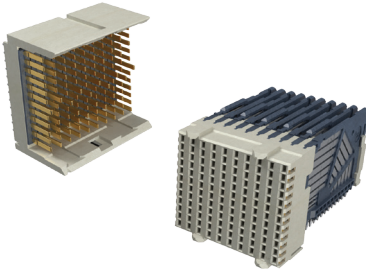
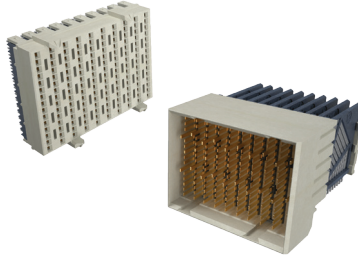
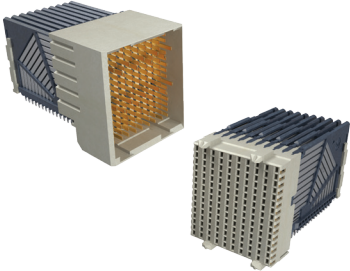
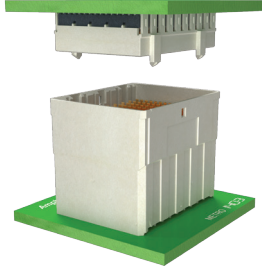
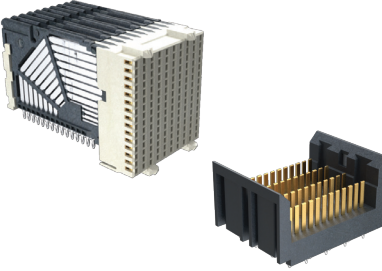
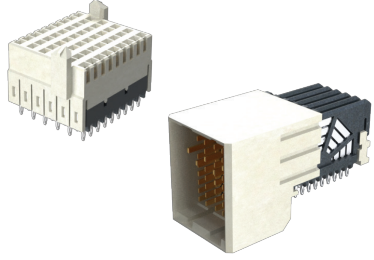
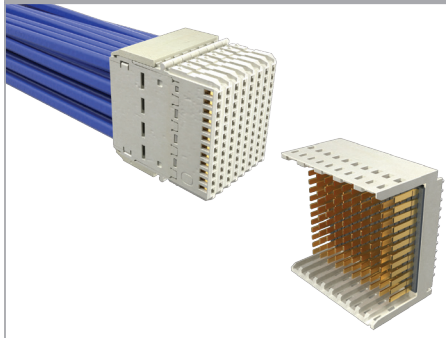
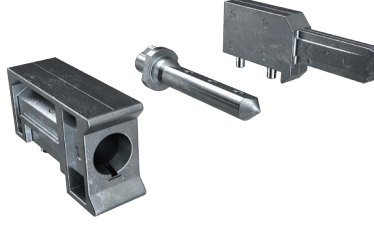
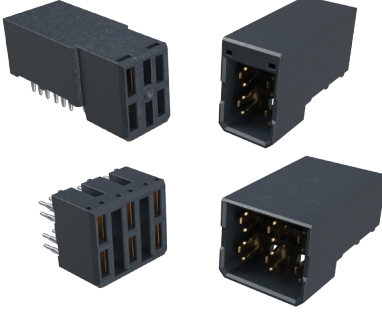
<p>AirMax VS® Traditional Mother Daughter Board Connectors – Backpanel Header with Right Angle Receptacle on Daughter Card</p>	<p>AirMax VS® Inverse Gender – Backplane Receptacle with Right Angle Header on Daughter Card</p>	<p>AirMax VS® Coplanar</p>
		
<p>AirMax VS® Mezzanine Connector</p>	<p>AirMax VS® CompactPCI Serial</p>	<p>AirMax® Storage Bridge Bay (SBB) Connectors</p>
		
<p>AirMax VS® I/O Cable Assemblies</p>	<p>External Guidance Modules</p>	<p>AirMax® Power</p>
		

AirMax VS® 12.5Gb/s BACKPLANE CONNECTOR SYSTEM

TECHNICAL INFORMATION

SIGNAL INTEGRITY PERFORMANCE

AirMax VS® VH-RAR 4pr 2mm- Power-Summed Crosstalk

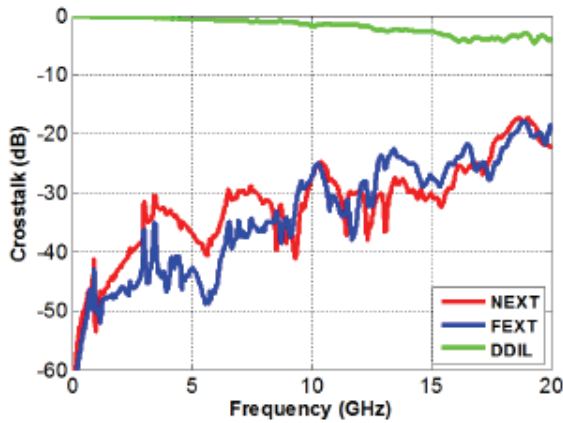

ELECTRICAL PERFORMANCE

- Contact Resistance: $\leq 35m\Omega$ I initial, $\leq 10m\Omega$ increase after environmental test
- Current Rating ($\leq 30^\circ C$ rise above ambient in still air): 0.5A/contact with all contacts powered
- Air dielectric provides lowest-possible insertion loss
- Optimized for lower crosstalk

MECHANICAL PERFORMANCE

- Durability: 200 cycles
- Mating Force: 0.45N max./contact
- Unmating Force: 0.15N min./contact
- Average Compliant Pin Insertion Force/pin:
 - 0.5mm PCB hole straight or right angle header pin and right angle receptacle pin: 40N max.
 - 0.5mm PCB hole straight receptacle of header pin: 25N max.
- Average Compliant Retention Force:
 - 0.5mm PCB hole straight or right angle header pin or right angle receptacle pin: 7N min.
 - 0.5mm PCB hole straight receptacle or orthogonal header pin: 3N min.

APPROVALS AND CERTIFICATIONS

- Telcordia GR-1217-CORE Central Office
- UL approved: UL File E66906

SPECIFICATIONS

- Product Specification: GS-12-239
- Application Specification: GS-20-035

PACKAGING

- Tubes
- Trays (vertical receptacle only)

MATERIALS

- Contacts: Copper Alloy
- Contact Finish:
 - Performance-based plating over nickel at separable interface
 - Tin over nickel on press-fit tails on standard lead-free products. Tin-lead option available upon request
- Housings: High Performance Thermoplastic, UL94V-0

CONNECTOR DENSITY

Minimum Card Slot Spacing (mm)	Column Pitch (mm)	Dimension A (mm)	Differential Pairs			Contacts		
			Per Column	Linear Density		Per Column	Linear Density	
				Per inch	Per cm		Per inch	Per cm
25	2	20.1	5	63.5	25	15	190.5	75
25	3	20.1	5	42.3	16.7	15	127	50
20	2	15.9	4	50.8	20	12	152.4	60
20	3	15.9	4	33.9	13.3	12	101.6	40
17	2	11.7	3	38.1	15	9	114.3	45
17	3	11.7	3	25.4	10	9	76.2	30

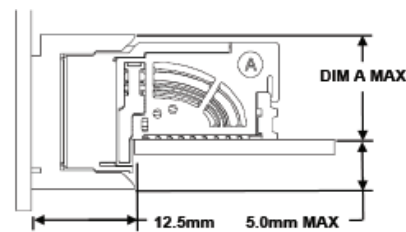

		Layout	
		mil	um
Column pitch	CP	79.0	2000
Trace	W	8.0	203
Space	S	8.0	203
Pad	P	36.0	914
Antipad	Wa	49.0	1245
Total Routing Width	TRW	24.0	610
Annular Ring	Wr	8.2	207
Clearance Drill-Trace	Cd-t	15.7	399
Clearance Pad-Trace	Cp-t	9.5	241
Clearance Antipad-Trace	Ca-t	3.0	76

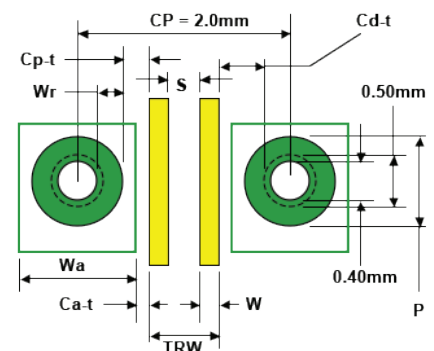

MOTHER-DAUGHTER BOARD APPLICATION

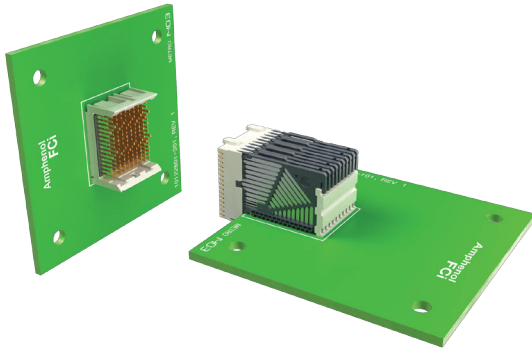

**AIRMAX VS® TRADITIONAL MOTHER DAUGHTER BOARD CONNECTORS –
BACKPLANE HEADER WITH RIGHT ANGLE RECEPTACLE ON DAUGHTER CARD: NO GUIDE**

AirMax VS® 100Ω Right Angle Header to Vertical Receptacle 0.5mm Press fit								
Part Numbers				Mating Connector System				Differential Impedance
Pairs	Columns	Differential Pairs	Columns Pitch	No Guide Pin – 2.0mm and 3.0mm Column Pitch				
				Right Angle Receptacle	Vertical Header 2 Wall	AirMax VS2® Vertical Header 2 wall	Vertical Header 4 Wall	
3	6	18	2.0mm	10053656-101LF	10056101-1050011LF	10115031-101LF	10056101-1080011LF	100Ω
	10	30	2.0mm	10056335-101LF	10056103-1050011LF	10139586-101LF	10056103-1080011LF	
4	8	32	2.0mm	10060905-101LF	10055307-1050011LF	10139587-101LF	10055307-1080011LF	100Ω
	8	32	3.0mm	10076645-101LF	10056429-1050011LF	-	10056429-1080011LF	
	10	40	2.0mm	10035754-101LF	10056100-1050011LF	10115025-101LF	10056100-1080011LF	
	10	40	3.0mm	10045722-101LF	10056430-1050011LF	-	10056430-1080011LF	
5	8	40	2.0mm	10045548-101LF	10055140-1050011LF	10139588-101LF	10055140-1080011LF	100Ω
	10	50	2.0mm	10034475-101LF	10056098-1050011LF	10115033-101LF	10056098-1080011LF	
	10	50	3.0mm	10057041-101LF	10056427-1050011LF	-	10056427-1080011LF	

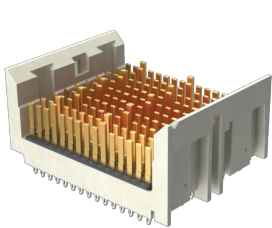

**Vertical Header –
2.0mm column pitch
(No Guide)**

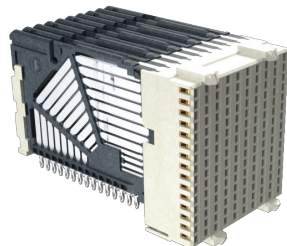

**Right Angle Receptacle –
2.0mm column pitch
(No Guide)**

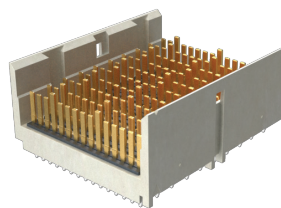

**Vertical Header –
3.0mm column pitch
(No Guide)**

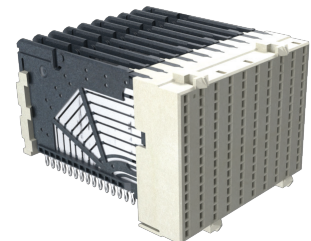

**Right Angle Receptacle –
3.0mm column pitch
(No Guide)**

**MOTHER-DAUGHTER BOARD APPLICATION
- INVERSE GENDER**

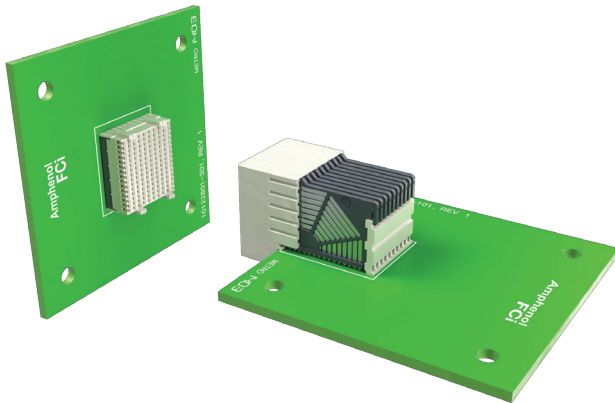

**AirMax VS® INVERSE GENDER MOTHER DAUGHTER BOARD CONNECTORS –
BACKPLANE RECEPTACLE WITH RIGHT ANGLE HEADER ON DAUGHTER CARD: NO GUIDE**

AirMax VS® 100Ω Right Angle Header to Vertical Receptacle 0.5mm Press fit							Differential Impedance
Part Numbers			Mating Connector System				
Pairs	Columns	Differential Pairs	Columns Pitch	No Guide Pin – 2.0mm and 3.0mm Column Pitch			
				Vertical Receptacle	Right Angle Header 2 Wall	Right Angle Header 4 Wall	
3	6	18	2.0mm	10043546-101LF	10040862-101LF	10039851-101LF	100Ω
	8	24	2.0mm	10045271-101LF	10045266-101LF	10045267-101LF	
	10	30	2.0mm	10034251-101LF	10034264-101LF	10034249-101LF	
4	6	24	2.0mm	10052829-101LF	10052824-101LF	10052825-101LF	100Ω
	8	32	2.0mm	10052842-101LF	10052837-101LF	10052838-101LF	
	10	40	2.0mm	10028264-101LF	10029391-101LF	10028436-101LF	
	10	40	3.0mm	10035465-101LF	10035514-101LF	10035515-101LF	
5	8	40	2.0mm	10040993-101LF	10041746-101LF	10041460-101LF	100Ω
	8	32	3.0mm	10064493-101LF	10064488-101LF	10064489-101LF	
	10	50	2.0mm	10016537-101LF	10016527-101LF	10025613-101LF	
	10	50	3.0mm	10035146-101LF	10037323-101LF	10037324-101LF	

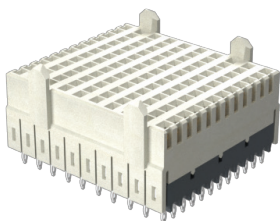

Vertical Receptacle (No Guide)

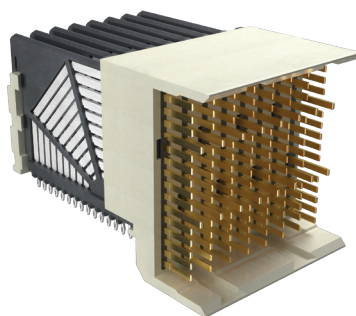

**Right Angle Header (No Guide)
2 Wall**

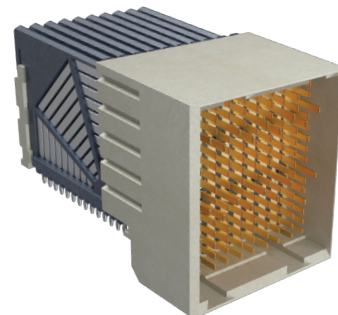

**Right Angle Header (No Guide)
4 Wall**

**AirMax VS® 12.5Gb/s
BACKPLANE CONNECTOR SYSTEM**

ORTHOGONAL MIDPLANE APPLICATION

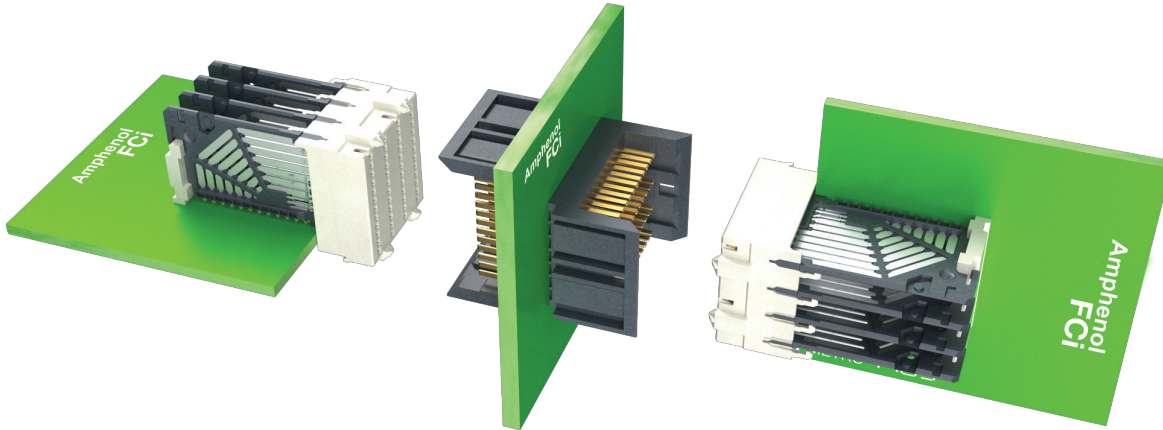

AirMax VS® ORTHOGONAL MIDPLANE SIGNAL MODULES

AirMax VS® 100Ω Right Angle Header to Vertical Receptacle 0.5mm Press fit					Differential Impedance
Part Numbers			Mating Connector System		
Pairs	Columns	Differential Pairs	No Guide Pin – 2.0mm Column Pitch		
			Vertical Receptacle	Right Angle Header 2 Wall	
4	4	16	10073718-101LF	10074050-101LF	100Ω

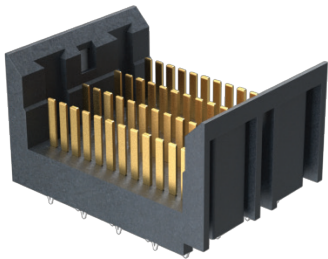

Vertical Header

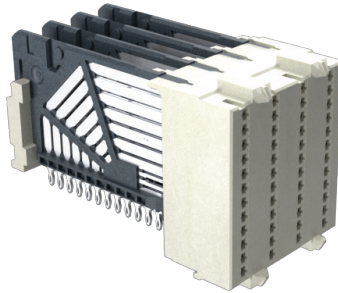

Right Angle Receptacle

AirMax® MEZZANINE CONNECTOR SYSTEM

AirMax VS® Mezzanine connectors use innovative edge-coupling and air dielectric between adjacent conductors to deliver low insertion loss and crosstalk. This technology enables low cost, high performance connectors that are a leading backplane interconnect solution for memory, storage, telecom, networking equipment and high speed I/O expansion in servers.

- Innovative edge-coupled design requires no internal ground shield between columns
- Low insertion loss and low crosstalk
- Shieldless open pin field design with no pre-assigned ground pins provides the ultimate flexibility in board layout
- 2 wall and 4 wall vertical header options



FEATURES

- Modules provide support for mezzanine applications such as memory, storage, telecom, networking equipment and high speed I/O expansion in servers
- The same vertical receptacle and header modules are used for backplane and midplane applications to accomplish 12.5mm stack height
- Taller vertical headers enable 26.0mm stack height
- Halogen-free connectors aid efforts to minimize the use of environment sensitive materials
- Press block for header installation also serves as a protective cover

BENEFITS

- Supports wide range of industry applications
- Minimizes the need for additional part numbers
- Supports wide range of connector sizes and applications
- Improves environmental performance
- Eliminates costly insertion tooling

TECHNICAL INFORMATION

ELECTRICAL PERFORMANCE

- Contact Resistance: $\leq 50\text{m}\Omega$ initial, $\leq 10\text{m}\Omega$ increase after environmental test
- Current Rating ($\leq 30^\circ\text{C}$ rise above ambient in still air): 0.5A/contact with all contacts powered
- Differential impedance: $100 \pm 5\Omega$ @ 100 ps (10–90%) rise time
- Differential insertion loss: < 0.5 dB through 3.12GHz, < 1 dB through 6.25GHz
- Near-end crosstalk (multi-active): < -39 dB through 3.12GHz; < -34 dB through 6.25GHz
- Far-end crosstalk (multi-active): < -42 dB through 3.12GHz; < -34 dB through 6.25GHz

MECHANICAL PERFORMANCE

- Durability: 200 cycles
- Mating Force: 0.45N max./contact
- Unmating Force: 0.15N min./contact
- Compliant pin insertion force: 40N max.

APPROVALS AND CERTIFICATIONS

- Telcordia GR-1217-CORE Central Office
- UL approved: UL File E66906

SPECIFICATIONS

- Product Specification: GS-12-239
- Application Specification: GS-20-035

PACKAGING

- Tubes
- Trays (vertical receptacle only)

MATERIALS

- Contacts: Copper Alloy
- Contact Finish:
 - Performance-based plating over nickel at separable interface
 - Tin over nickel on press-fit tails on standard lead-free products. Tin-lead option available upon request
- Housings: High Performance Thermoplastic, UL94V-0

CONNECTOR DENSITY

Minimum Card Slot Spacing (mm)	Column Pitch (mm)	Differential Pairs			Contacts		
		Per Column	Linear Density		Per Column	Linear Density	
			Per inch	Per cm		Per inch	Per cm
25	2	5	63.5	25	15	190.5	75
25	3	5	42.3	16.7	15	127	50
20	2	4	50.8	20	12	152.4	60
20	3	4	33.9	13.3	12	101.6	40
17	2	3	38.1	15	9	114.3	45
17	3	3	25.4	10	9	76.2	30

PART NUMBERS – 2.0mm and 3.0mm COLUMN PITCH



AirMax VS® MEZZANINE CONNECTORS

Pairs	Part Numbers		Column Pitch	Header Version	Signal Module Part Numbers			Module Width Along Card Edge (mm)	Total Contacts	Stack Height (mm)	Differential Impedance
	Columns	Differential Pairs			AirMax VS® Vertical Header	AirMax VS2® Vertical Header	Vertical Receptacle				
3	6	18	2.0mm	2-wall	10056101-1050011LF	10116601-101LF	10043546-101LF	12	54	12.5	100Ω
	10	30	2.0mm	4-wall	10056103-1080011LF	-	10034251-101LF	22	90	12.5	
	10	30	2.0mm	2-wall	10056103-1050011LF	10130519-101LF	10034251-101LF	20	90	12.5	
4	8	32	2.0mm	2-wall	10055307-1050011LF	10130531-101LF	10052842-101LF	16	96	12.5	100Ω
	10	40	2.0mm	4-wall	10056100-1080011LF	-	10028264-101LF	22	120	12.5	
	10	40	2.0mm	2-wall	10056100-1050011LF	10117992-101LF	10028264-101LF	20	120	12.5	
	10	40	3.0mm	4-wall	10056430-1080011LF	-	10035465-101LF	32	120	12.5	
	10	40	3.0mm	2-wall	10056430-1050011LF	-	10035465-101LF	30	120	12.5	
5	8	40	2.0mm	2-wall	10055140-1050011LF	10130530-101LF	10040993-101LF	16	120	12.5	100Ω
	10	50	2.0mm	2-wall	10056098-1050011LF	10116602-101LF	10016537-101LF	20	150	12.5	
	10	50	2.0mm	4-wall	10056246-1071LF	-	10016537-101LF	22	150	26	
	10	50	3.0mm	2-wall	10056427-1050011LF	-	10035146-101LF	30	150	12.5	
	10	50	3.0mm	4-wall	10059957-1071LF	-	10035146-101LF	32	150	26	

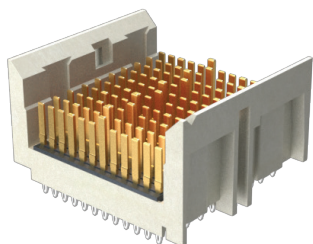

**Vertical Header
2 Wall**

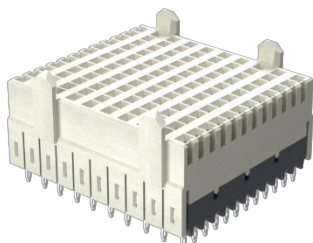

Vertical Receptacle

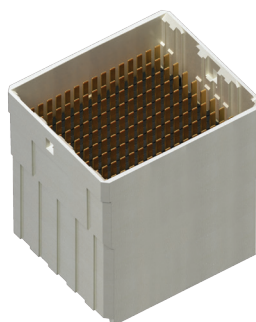

**Vertical Header
4 Wall**

AirMax VS[®] 85Ω CONNECTOR SYSTEM

AirMax VS[®] 85Ω connectors are optimized to minimize impedance discontinuities and signal loss when inserted in 85Ω channels. Mating interface supports backward compatibility to legacy 100Ω product interfaces, ensuring a smooth transition to next generation designs.

- Full compliance with differential insertion loss, impedance and crosstalk requirements defined in the Intel[®] QPI connector specifications
- 6.4Gb/s to more than 8Gb/s per lane transfer rates between processors or processors and I/O controllers lowers memory bandwidth utilization
- Enables multiple bi-directional 10GbE ports in a server



FEATURES

- Tested and fully compliant with Intel[®] QPI Connector Specifications
- Headers and receptacles in right angle and vertical configurations
- Modular, hard metric connector design
- Power connector and guide modules
- Halogen-free housing materials

BENEFITS

- Supports increased QPI link speeds of 6.4Gb/s > 8Gb/s
- Supports backplane and coplanar applications
- 2.0mm pitch for high density application
- 3.0mm pitch enables quad routing and lower PCB cost
- Complements and completes the full range of product
- Meets next generation environmental requirements

TECHNICAL INFORMATION

SIGNAL INTEGRITY PERFORMANCE

AirMax VS® 85Ω RAH VR 5pr 2.0mm – 20 Point Average

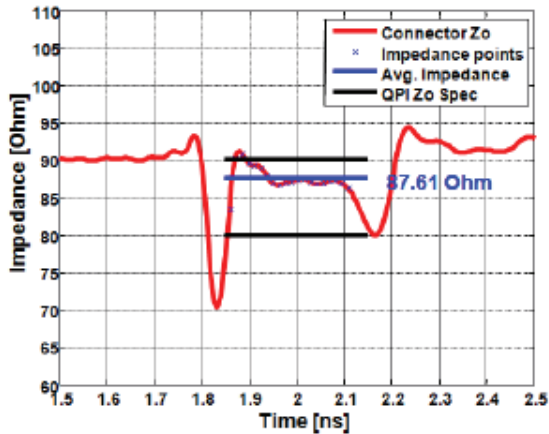

AirMax VS® 85Ω RAH VR 5pr 2.0mm – 20 Point Average

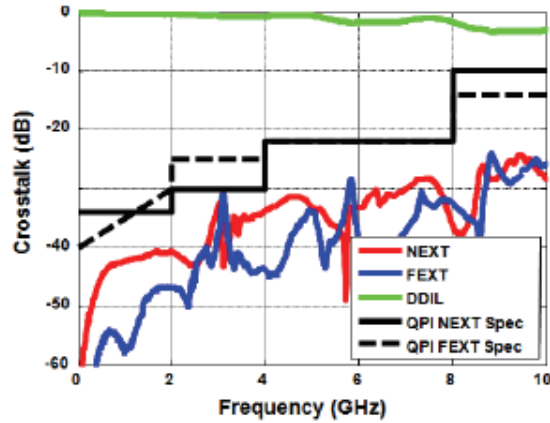

ELECTRICAL PERFORMANCE

- Average differential impedance: 85Ω±/– 5Ωs @ 50ps (10–90%) risetime
- Insertion loss: <1.5 dB through 4GHz
- Differential impedance: 100 ±11Ω @ 50ps (20–80%) rise time
- Worst-case multi-active near-end crosstalk: <–30 dB through 4GHz
- Worst-case multi-active far-end cross talk: <–30 dB through 4GHz

MECHANICAL PERFORMANCE

- Mating force: 0.45 N max. per contact
- Unmating force: 0.15 N min. per contact
- Press-fit insertion force: 40 N max. per compliant tail except for vertical receptacle which is 25 N max. per tail

ENVIRONMENTAL

- Per Telcordia Central Office requirements

APPROVALS AND CERTIFICATIONS

- Telcordia GR-1217-CORE Central Office
- UL approved: UL File E66906

SPECIFICATIONS

- Product Specification Document #: GS-12-239
- Application Specification Document #: GS-12-035

PACKAGING

- Tubes
- Trays (vertical receptacle only)

MATERIALS

- Contacts: Copper alloy
- Plating: Performance-based plating at separable interface (Telcordia GR-1217 CORE Central Office)
- Housings: High-temperature thermoplastic, UL94V-0

CONNECTOR DENSITY

Minimum Card Slot Spacing (mm)	Column Pitch (mm)	Differential Pairs			Contacts		
		Per Column	Linear Density		Per Column	Linear Density	
			Per inch	Per cm		Per inch	Per cm
25	2	5	63.5	25	15	190.5	75
25	3	5	42.3	16.7	15	127	50
17	2	3	38.1	15	9	114.3	45

MOTHER-DAUGHTER BOARD APPLICATION

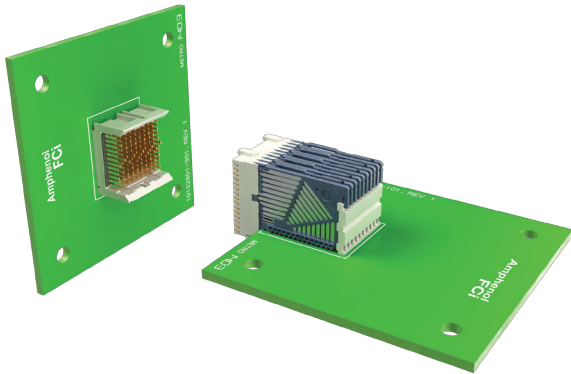

AirMax VS® 85Ω TRADITIONAL MOTHER-DAUGHTER BOARD CONNECTORS BACKPLANE HEADER WITH RIGHT ANGLE RECEPTACLE ON DAUGHTER CARD: NO GUIDE

AirMax VS® 85Ω Right Angle Header to Vertical Receptacle 0.5mm Press fit							Differential Impedance
Part Numbers				Mating Connector System			
Pairs	Columns	Differential Pairs	Column Pitch	No Guide Pin – 2.0mm Column Pitch			
				Right Angle Receptacle	Vertical Header 2 Wall	Vertical Header 4 Wall	
5	8	40	2.0mm	10136965-101LF	10095575-1050011LF	10095575-1080011LF	85Ω
	10	50	2.0mm	10095504-101LF	10095500-1050011LF	10095500-1080011LF	
	10	50	3.0mm	10095505-101LF	10073377-1050011LF	10073377-1080011LF	

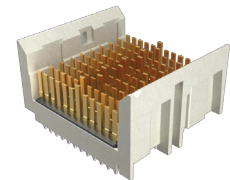

Vertical Header

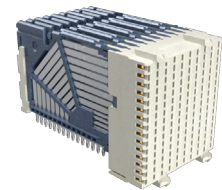

Right Angle Receptacle

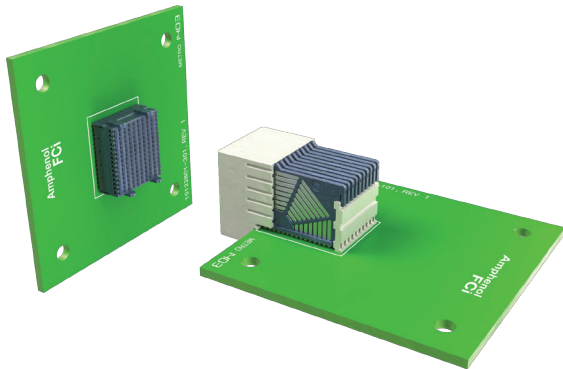

AirMax VS® 85Ω INVERSE GENDER BACKPLANE RECEPTACLE WITH RIGHT ANGLE HEADER ON DAUGHTER CARD: NO GUIDE

AirMax VS® 85Ω Right Angle Header to Vertical Receptacle 0.5mm Press fit						
Part Numbers				Mating Connector System		Differential Impedance
Pairs	Columns	Differential Pairs	Column Pitch	No Guide Pin – 2.0mm Column Pitch		
				Vertical Receptacle	Right Angle Header 4 Wall	
3	6	18	2.0mm	10096461-101LF	10097256-101LF	85Ω
5	8	40	2.0mm	-	-	85Ω
	10	50	2.0mm	10099767-101LF	10097311-101LF	
	10	50	3.0mm	10099768-101LF	10087771-101LF	

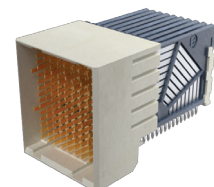

Right Angle Header

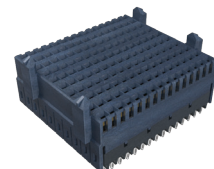

Vertical Receptacle

COPLANAR APPLICATION

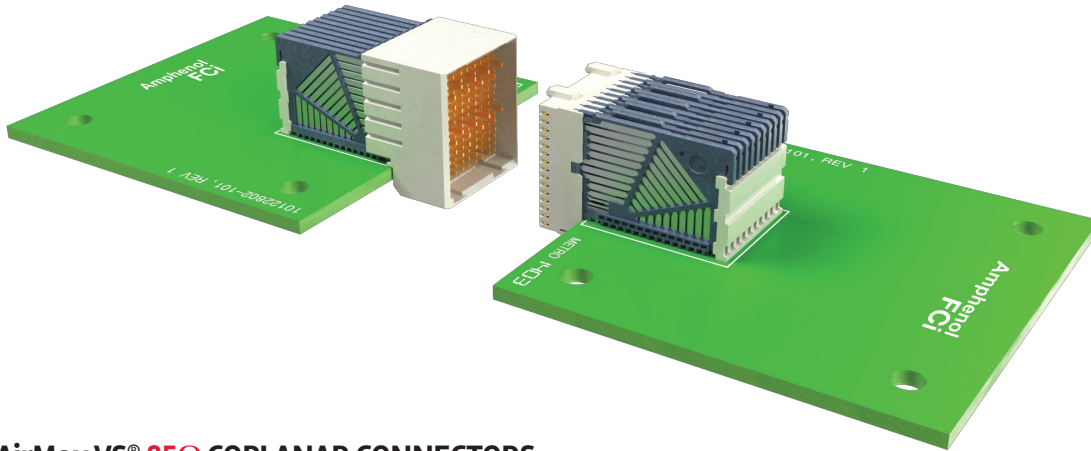

AirMax VS® 85Ω COPLANAR CONNECTORS

AirMax VS® 85Ω Right Angle Header to Vertical Receptacle 0.5mm Press fit					
Part Numbers			Column Pitch	Mating Connector System	
Pairs	Columns	Differential Pairs		No Guide Pin – 2.0mm Column Pitch	
				Right Angle Header 4 Wall	Right Angle Receptacle
5	10	50	2.0mm	10097311-101LF	10095504-101LF
	10	50	3.0mm	10087771-101LF	10095505-101LF

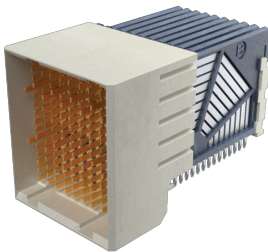

Right Angle Header

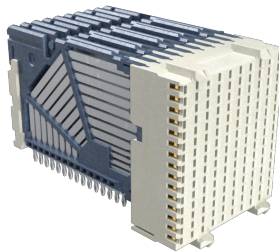

Right Angle Receptacle

AirMax® HIGH SPEED CONNECTOR SYSTEM

For CompactPCI® Serial

AirMax® high speed signal connectors meet the dimensional and electrical requirements described in CompactPCI® Serial (PICMG CPCI-S.0) specification. It moves CompactPCI® architecture to high speed serial interconnects to add greater support for serial point to point fabrics like PCI Express®, SATA, Ethernet and USB in the classic CompactPCI® form factor with mechanics fully compliant to IEC 1101.

- Hybrid systems integrates with legacy CompactPCI® boards and newer CompactPCI® Serial boards
- Connections between a front system or peripheral board and backplane are accomplished using right angle headers and vertical receptacles
- The interface to a rear I/O board uses right angle receptacles and vertical headers
- Shieldless open pin field design with no pre-assigned ground pins provides the ultimate flexibility in board layout



FEATURES

- Meets the mechanical and electrical requirements of the CompactPCI® Serial specification
- Innovative shieldless edge-coupling technology and air dielectric between adjacent conductors
- Grounds can be assigned to low speed signals
- Opposed dual beam receptacle contact structure
- Halogen-free housing materials

BENEFITS

- Supports PCI Express®, SATA/SAS, USB 2.0/3.0 and 10GB Ethernet high speed interfaces
- Superior electrical performance delivers low insertion loss and low crosstalk
- Allows mixing of differential pair signals, single ended signals, power and control lines within standard connector module
- Maximizes pin assignment flexibility
- Provides high reliability
- Meets next generation environmental requirements

TECHNICAL INFORMATION

ELECTRICAL PERFORMANCE

- Contact Resistance: $\leq 35m\Omega$ initial, $\leq 10m\Omega$ increase after environmental test
- Current Rating ($\leq 30^\circ C$ rise above ambient in still air): 0.5A/contact with all contacts powered
- Differential impedance: $100 \pm 6\Omega$ @ 80 ps (10–90%) rise time
- Differential insertion loss: < 1.5 dB through 3.12GHz;
- < 3.5 dB through 6.25GHz
- Near-end crosstalk (multi-active): < -33 dB through 3.12GHz; < -28 dB through 6.25GHz
- Far-end crosstalk (multi-active): < -31 dB through 3.12GHz; < -25 dB through 6.25GHz

MECHANICAL PERFORMANCE

- Durability: 200 cycles
- Mating Force: 0.45N max./contact
- Unmating Force: 0.15N min./contact
- Average Compliant Pin Insertion Force/pin:
 - 0.5mm PCB hole straight or right angle header pin and right angle receptacle pin: 40N max.
 - 0.5mm PCB hole straight receptacle of header pin: 25N max.
- Average Compliant Retention Force:
 - 0.5mm PCB hole straight or right angle header pin or right angle receptacle pin: 7N min.
 - 0.5mm PCB hole straight receptacle or orthogonal header pin: 3N min.

APPROVALS AND CERTIFICATIONS

- Telcordia GR-1217-CORE Central Office
- UL approved: UL File E66906

ADDITIONAL INFORMATION

- AirMax VS High-Speed Connector System: Signal Integrity Test Procedures and Performance
- Use web link: www.fciconnect.com/cpciserial to obtain specifications, product drawings and additional technical information

SPECIFICATIONS

- CompactPCI® Serial Specification (reference: www.picmg.org)
- Telcordia GR-1217-CORE Central Office
- Product Specification Document #: GS-12-239
- Application Specification Document #: GS-20-035

PACKAGING

- Tubes

MATERIALS

- Contacts: Copper Alloy
- Contact Finish:
 - Performance-based plating over nickel at separable interface
 - Tin over nickel on press-fit tails on standard lead-free products. Tin-lead option available upon request
- Housings: High Performance Thermoplastic, UL94V-0

CONNECTOR DENSITY

Minimum Card Slot Spacing (mm)	Column Pitch (mm)	Differential Pairs			Contacts		
		Per Column	Linear Density		Per Column	Linear Density	
			Per inch	Per cm		Per inch	Per cm
20	2	4	50.8	20	12	152.4	60
20	3	4	33.9	13.3	12	101.6	40

PART NUMBERS

AirMax® CompactPCI® Serial

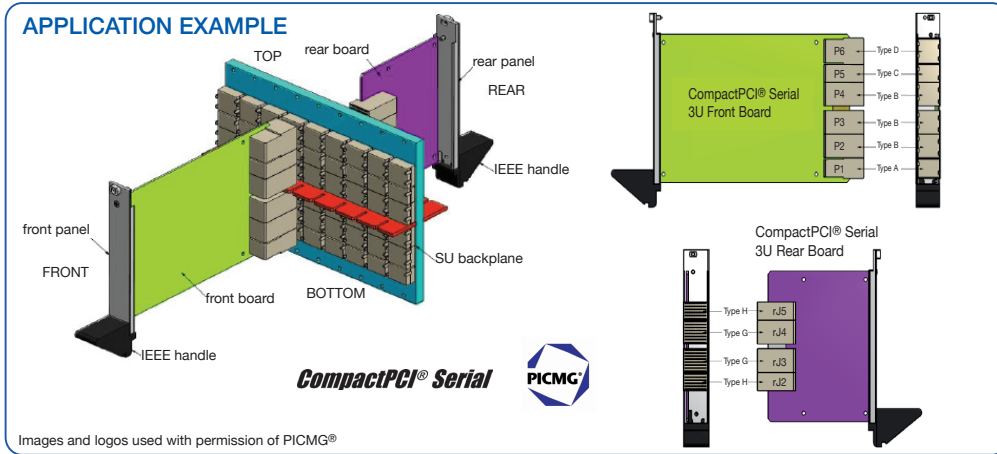

AirMax® CompactPCI® Serial Connectors

Front Daughter Card Connectors (Right-Angle Headers)					Midplane Front Side Connectors (Vertical Receptacles)		
Designator	Type	Columns	Walls	FCI - Part Number	Designator	Type	FCI - Part Number
P0	A	6	4	10052825-101LF	J0	E	10052829-101LF
P1	A	6	4	10052825-101LF	J1	E	10052829-101LF
P2	B	8	2	10052837-101LF	J2	F	10052842-101LF
P3	B	8	2	10052837-101LF	J3	F	10052842-101LF
P4	B	8	2	10052837-101LF	J4	F	10052842-101LF
P5	C	6	2	10052824-101LF	J5	E	10052829-101LF
P6	D	8	4	10052838-101LF	J6	F	10052842-101LF

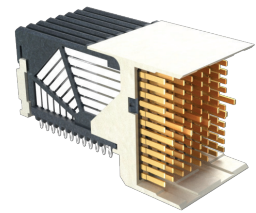

Right Angle Header

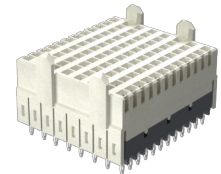

Vertical Receptacle

Midplane Rear Side Connectors (Vertical Headers)					Rear Daughter Card Connectors (Right-Angle Receptacles)		
Designator	Type	Columns	Walls	FCI - Part Number	Designator	Type	FCI - Part Number
rP2	J	6	2	10114761-101LF	rJ2	H	10114633-101LF
rP3	I	8	2	10114760-101LF	rJ3	G	10060905-101LF
rP4	I	8	2	10114760-101LF	rJ4	G	10060905-101LF
rP5	J	6	2	10114761-101LF	rJ5	H	10114633-101LF

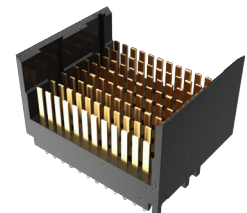

Vertical Header

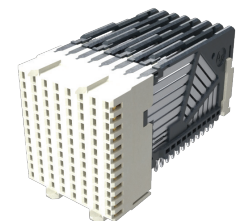

Right Angle Receptacle

AirMax® STANDARD PROFILE AND EXTENDED HEIGHT HIGH SPEED CONNECTOR SYSTEM

For Storage Bridge Bay (SBB) Midplane Interface

The Storage Bridge Bay (SBB) Specification, targeted at low and midrange storage, provides requirements, guidelines and reference information to ensure compatibility between a storage enclosure controller slot and storage controllers from a variety of independent vendors. The specification defines the mechanical and electrical interfaces between a storage controller and the midplane within a storage enclosure. AirMAX® Storage Bridge Bay (SBB) is offered in two different versions, VS® standard profile and VS2® extended-height SBB.

Any bridge/controller card supplied in accordance with this specification will be compatible and accommodated within any storage enclosure slot designed in conformance to the SBB specification. Examples include JBOD interface bridges and RAID, iSCSI SAN, Fibre Channel SAN or NAS controllers.

In addition, the AirMAX VS2® extended height SBB results in lower system costs and scalable memory performance, via higher density DIMMs. Designers can specify Standard DDR4 DIMM to be used in existing enclosures with upgraded SBB canisters. The VLP 15GB DIMM results in memory cost premiums. Standard height 32G RDIMM and 64G LRDIMM offer a lower cost and higher memory. Also, while AirMAX VS® Standard SBB is press-fit, the extended height version is pin in paste (PiP).

AirMAX® high-speed signal connectors, guide modules, and power connectors meet the dimensional and electrical requirements for the Storage Bridge Bay Midplane Interface (SBBMI) to connect bridge/controller cards to the midplane in a drive enclosure.



TARGET MARKETS



FEATURES

- Shieldless design and air dielectric between adjacent conductor
- High Speed data rates can scale from 2.5Gb/s to 12.5Gb/s
- Opposed dual-beam receptacle contact structure
- Contains no interleaving shields
- Compact 2x2 power connectors
- Rugged guide modules
- Low profile design

BENEFITS

- Delivers low insertion loss and crosstalk
- Does not require a redesign of the basic platform
- Provides high reliability
- Reduces connector cost, weight and PCB routing complexity
- Provides capacity for up to 20A/ contact
- Offers ESD grounding option
- Helps to facilitate airflow through the canister for cooling

AirMax VS® HIGH SPEED CONNECTOR SYSTEM FOR STORAGE BRIDGE BAY

TECHNICAL INFORMATION

ELECTRICAL PERFORMANCE

- Contact Resistance: 35mΩ initial, 10mΩ increase after environmental test
- Current Rating (30°C rise above ambient in still air): 0.5A/contact with all contacts powered
- Differential impedance: 100 ± 6Ω @ 80 ps (10–90%) rise time
- Differential insertion loss: < 1.5 dB through 3.12GHz; < 3.5 dB through 6.25GHz
- Near-end crosstalk (multi-active): < -28 dB through 3.12GHz ; < -25 dB through 6.25GHz
- Far-end crosstalk (multi-active): < -218dB through 3.12GHz; < -25 dB through 6.25GHz

MECHANICAL PERFORMANCE

- Durability: 200 cycles
- Mating Force: 0.45N max./contact
- Unmating Force: 0.15N min./contact
- Average Compliant Pin Insertion Force/pin:
 - 0.5mm PCB hole straight or right angle header pin and right angle receptacle pin: 40N max.
 - 0.5mm PCB hole straight receptacle of header pin: 25N max.
- Average Compliant Retention Force:
 - 0.5mm PCB hole straight or right angle header pin or right angle receptacle pin: 7N min.
 - 0.5mm PCB hole straight receptacle or orthogonal header pin: 3N min.

APPROVALS AND CERTIFICATIONS

- Telcordia GR-1217-CORE Central Office
- UL approved: UL File E66906

ADDITIONAL INFORMATION

- AirMax VS® High-Speed Connector System: Signal Integrity Test Procedures and Performance

STANDARD AND EXTENDED HEIGHT SBB

Product	Column Pitch	Memory	Board Mount
AirMax VS® Standard Profile SBB	2.00mm	8G DIMM 16G DIMM 16G VLP DIMM	Press-fit
AirMax VS2® Extended Height SBB	2.00mm	32G RDIMM 64G LRDIMM	Pin-in-Paste (PiP)

SPECIFICATIONS

- Storage Bridge Bay Specification (reference www.sbbwg.org)
- Telcordia GR-1217-CORE, Central Office
- Press-fit signal connector Product Specification Document #: GS-12-239
- Press-fit high-power contacts Product Specification Document #: GS-12-220
- Press-fit signal connectors Application Specification Document #: GS-20-035
- Press-fit high power connectors Application Specification Document #: GS-20-023
- Hard-metric guide connectors Application Specification Document #: GS-20-045

PACKAGING

- Tubes

MATERIALS

- Contacts: Copper Alloy
- Contact Finish:
 - Performance-based plating over nickel at separable interface
 - Tin over nickel on press-fit tails on standard lead-free products. Tin-lead option available upon request
- Housings: High Performance Thermoplastic, UL94V-0

CONNECTOR DENSITY

Minimum Card Slot Spacing (mm)*	Column Pitch (mm)	Differential Pairs			Contacts		
		Per Column	Linear Density		Per Column	Linear Density	
			Per inch	Per cm		Per inch	Per cm
17	2.0	3	38.1	15.0	9	114.3	45

*17.0mm min. card slot is for signal modules only

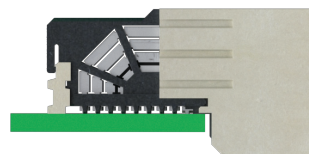

AirMax VS® Standard Profile SBB

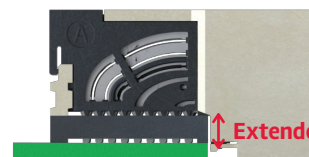

AirMax VS2® Extended Height SBB

AirMax VS® HIGH SPEED CONNECTOR SYSTEM FOR STORAGE BRIDGE BAY



PART NUMBERS

AirMax VS® FOR STORAGE BRIDGE BAY



Midplane Board

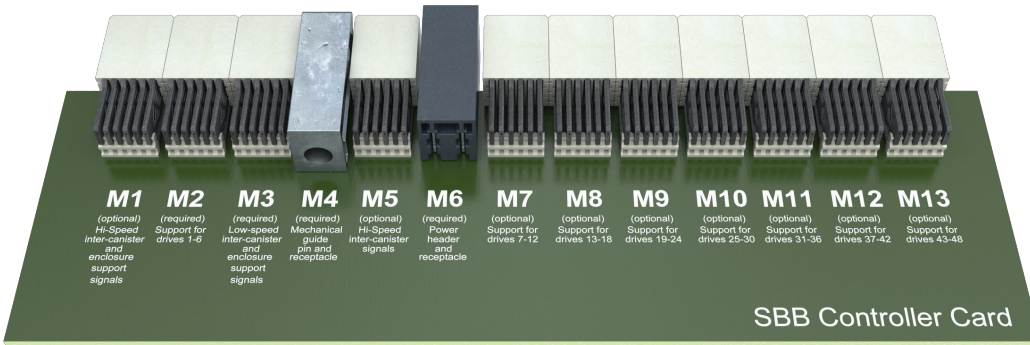

SBB Canister Controller Card

3Gb/s SAS Signal Profile 2Gb/s or 4Gb/s Fibre Channel Signal Profile	Module Description	SBB Midplane	SBB Canister/Controller Card
AirMax® 3 pair, 6 column signal modules	M1-M3, M5, M7-M13	10043546-101LF	10039851-101LF
AirMax® guide module	M4	10037911-102LF	<p>SAS Signal Profile Key 10037912-104LF (with ESD contact) or 10037912-114LF (without ESD contact)</p> <p>Fibre Channel Signal Profile Key 10037912-102LF (with ESD contact) or 10037912-112LF (without ESD contact)</p>
AirMax® power module	M6	10028916-4555P00LF	10028917-001LF (14.7mm above PCB) or 10073379-001LF (11.5mm above PCB)

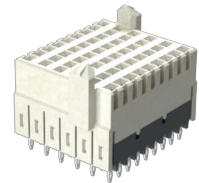

SBB Midplane

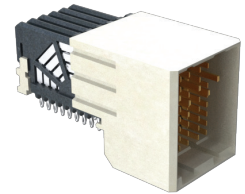

AirMax VS® SBB Canister/Controlled Card

AirMax VS® Standard Profile SBB

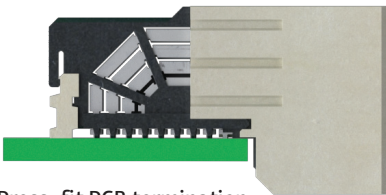

Press-fit PCB termination

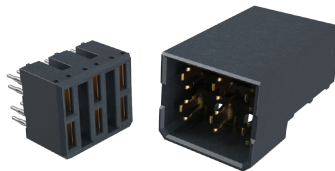

Power Modules

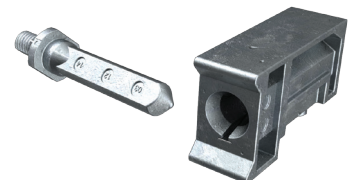

Guide Modules

AirMax VS[®] HIGH SPEED CONNECTOR SYSTEM FOR STORAGE BRIDGE BAY

PART NUMBERS

AirMax VS2[®] EXTENDED HEIGHT FOR STORAGE BRIDGE BAY

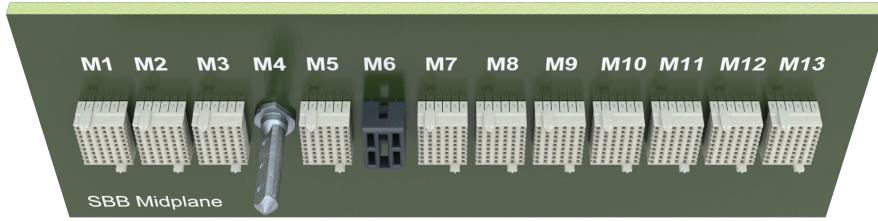

Midplane Board

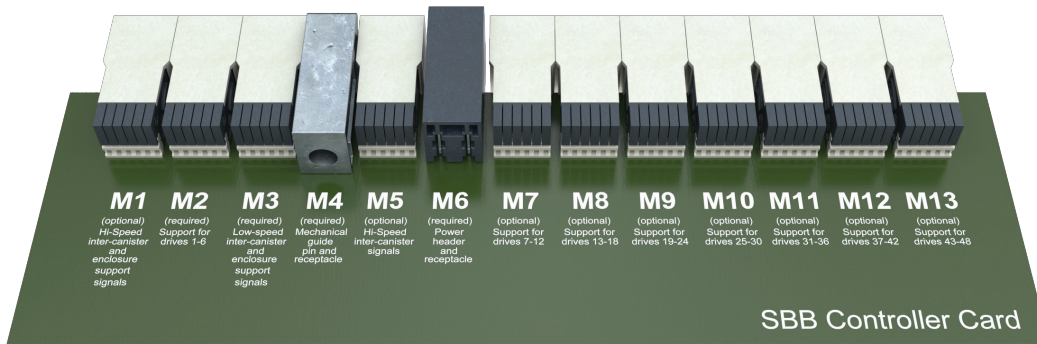

SBB Canister Controller Card

3Gb/s SAS Signal Profile or 2Gb/s or 4Gb/s Fibre Channel Signal Profile	Module Description	SBB Midplane	SBB Canister/Controller Card (3mm Extended Height)
AirMax [®] 3 pair, 6 column signal modules	M1-M3, M5, M7-M13	10043546-101LF	10137974-101LF
AirMax [®] guide module	M4	10037911-102LF	SAS Signal Profile Key 10138129-104LF (with ESD contact) or 10138129-114LF (without ESD contact) Fibre Channel Signal Profile Key 10138129-104LF (with ESD contact) or 10138129-114LF (without ESD contact)
AirMax [®] power module	M6	10028916-4555P00LF	10138108-101LF

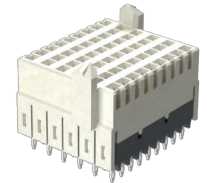

SBB Midplane

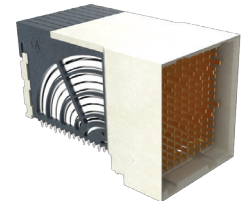

AirMax VS2[®] SBB Canister/Controller Card

AirMax VS2[®] Standard Profile SBB

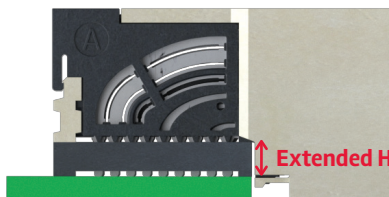

Pin-in-Paste PCB termination



Power Modules



Guide Modules

AirMax VS® I/O CONNECTORS & CABLE ASSEMBLIES

AirMax VS® I/O connectors and cable assemblies is the first interconnect system to use innovative edge-coupling and air dielectric between adjacent conductors to deliver 63.5 differential pairs per inch while exhibiting low insertion loss and crosstalk. This system allows scalable differential signal transmission from 2.5Gb/s up to 12.5Gb/s per channel without costly redesign.

- AirMax VS® I/O cable assemblies has 4 differential pairs per column with wafers spaced on 2.0mm centerlines, in 96 or 120 positions
- AirMax VS® I/O connectors in vertical and right angle configurations
- Cable mates to the board headers via a passive latching system
- Customized I/O solutions such as alternative retention methods like active latch or jack screws, and overall EMI shielding to address external front panel or rear plug I/O cabling

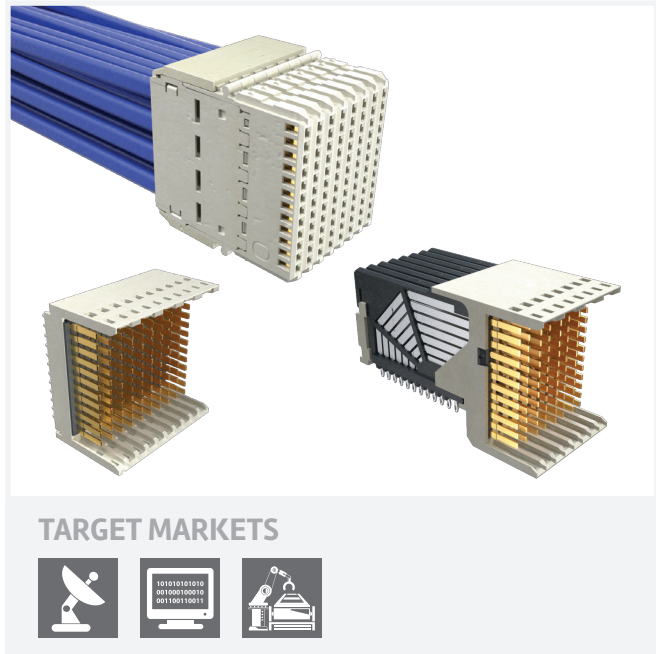

FEATURES

- Innovative shieldless edge-coupling technology and air dielectric between adjacent conductors
- Provides a scalable migration path from 2.5Gb/s to beyond 10Gb/s per differential pair
- Internal or external cabling options
- 26 or 30AWG twin axial cable options, up to 5meters in length
- 100Ω impedance performance
- Modular and scalable design from 4 to 20 columns

BENEFITS

- Superior electrical performance delivers low insertion loss and low crosstalk
- Scalable system architecture without costly redesign
- Provides equipment design flexibility
- Meets industry standards such as SAS, SATA, IEEE and PCIe®
- Supports bandwidths up to 10Gb/s
- Fits designs requiring 100Ω differential impedance
- Enables designers to accommodate varying signal pair counts using different product configurations

TECHNICAL INFORMATION

ELECTRICAL PERFORMANCE

- Differential Impedance: 100Ω +/- 10 @ 70ps rise time (20–80%)
- Within Pair skew: < 10ps/meter
- Pair-to-pair skew: < 50ps/meter
- Withstanding voltage: 300V DC
- Current rating: 0.5A max. per contact

MECHANICAL PERFORMANCE

- Durability: 50 cycles
- Mating force: 0.6 N max. per contact
- Unmating force: 0.15 N min. per contact
- Cable axial strain relief – 90 N min.
- Cable flex: 140° flex; 25 cycles per EIA 364–41

APPROVALS AND CERTIFICATIONS

- Operating temperature range: –20°C to 85°C
- RoHS compliant
- Thermal shock – EIA 364–32, Condition 1, 5 cycles, –55°C to 85°C
- Temperature life – EIA 364–17, Method A, condition 3, Time Condition C, 500 hours, 85°C
- Mixed Flowing gas – EIA 364–65, Class IIA – 10 days unmated and 10 days mated

SPECIFICATIONS

- Cable Assembly Product Specification Document #: GS-12-1039
- Cable I/O Receptacle Product Specification Document #: GS-12-344

MATERIALS

- Copper Alloy
- Housings: High temperature thermoplastic; UL94V–O compliant
- Plating(s): Performance– based plating at separable interface; tin over nickel on press fit tails
- Raw Cable: Ag plated copper conductors with foam insulation covered by conductive foil
- Internal cables bundled with halogen–free snakeskin jacketing

APPLICABLE INDUSTRY STANDARDS

- According to customer system application interface

CONNECTOR DENSITY

Minimum Card Slot Spacing (mm)	Column Pitch (mm)	Differential Pairs		
		Per Column	Linear Density	
			Per inch	Per cm
20	2	4	50.8	20
20	3	4	33.9	13.3

PART NUMBERS

Pairs	Columns	Differential Pairs	Vertical Header	Right Angle Header	Cable Assembly	Differential Impedance
4	8	32	–	10061399 –101LF	10122257	100Ω
	10	40	10041268–1010031LF	10041398–101LF	10110653	

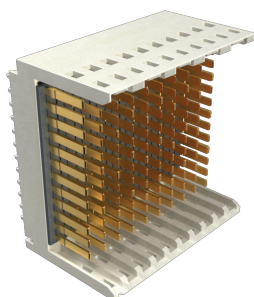

**Vertical Header
2 Wall**

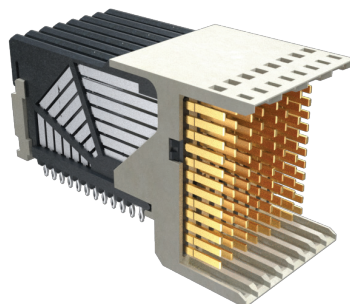

**Right Angle Header
2 Wall**

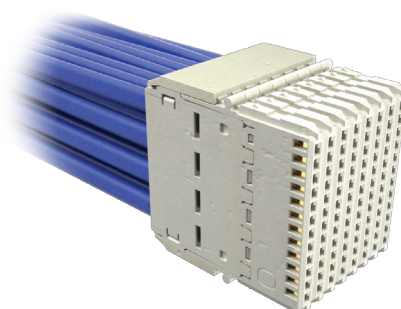

Cable Assembly

AirMax® POWER CONNECTOR MODULES

Hard Metric high power connectors are a perfect complement to ExaMAX®, AirMax®, ZipLine® and Millipacs® signal connectors. These power connectors mount alongside their signal counterparts and are used in applications where bulk current is delivered by backplane or midplane to power consuming components on a mating daughter card.

- Multiple points of contacts– made of high conductivity copper alloy
- Unique housing design allows airflow
- 1x2 version carries 40Amps per contact for a total of 80Amps per module
- 2x2 and 2x3 versions carry 20Amps per contact
- UL 60950 compliant (Finger Safe)



FEATURES

- High conductivity alloys plus air venting in the housings
- Hard Metric equipment practice
- Options for first-mate/last-break sequencing with 2 pin heights
- Finger safe backplane receptacles
- Press-fit termination
- High Temperature housings suitable for reflow process

BENEFITS

- Enables up to 80Amps in a 1x2 or 2x2 module only 12.0mm wide
- Assures compatibility with any Hard Metric signal connectors
- Optimizes board edge real estate
- Enables hot pluggable designs assuring very high system up times
- Assures operator safety
- Fits any PCB assembly process

TECHNICAL INFORMATION

ELECTRICAL PERFORMANCE

- Current Rating: See table for maximum amps per contact for test configurations with dual (double sided) external copper pads of noted weight
- Operating voltage: 150V max.
- Dielectric withstanding voltage: 1500V
- Insulation resistance: >10,000MΩ min.
- Contact Resistance: 1.0mΩ initially and after environmental exposure

MECHANICAL PERFORMANCE

- Durability: 200 cycles

APPROVALS AND CERTIFICATIONS

- UL 60950 & IEC 60950-1 Prevention of Operator Access to Energized Parts
- Telcordia GR-1217-CORE Central Office

TEMPERATURE RISE CURVE

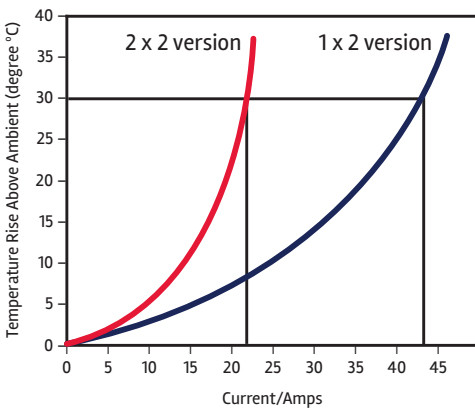

Current information is in still air (no air flow) with multiple contacts energized unless otherwise noted

SPECIFICATIONS

- Cable Assembly Product Specification Document: GS-12-220
- Cable I/O Receptacle Product Specification Document: GS-20-023

PACKAGING

- Tubes

MATERIALS

- Housing: High-temperature thermoplastic (UL94V-0)
- Contact base metal: Copper alloy
- Contact Finish
 - Separable interface: Performance-based plating over nickel
- Termination area: Tin or tin-lead over nickel

Receptacle Type	Number of Connectors Fully Powered	Copper Pad Weight	Maximum Current Per Contact	
			1X2	2X2
Vertical Receptacle (2X2)	1	5oz	40A	20A
	Up to 5 adjacent	5oz	32A	14A
	1	2oz	32A	15A
	Up to 5 adjacent	2oz	27A	12A
Right Angle Receptacle (2X2)	1	2oz	37A	18A
	Up to 5 adjacent	2oz	29A	14A

*Results based on 2 layer test cards for listed copper weight

PART NUMBERS

AirMax® POWER CONNECTORS

Hard Metric Backplane/Midplane Power Modules									
Minimum Card Slot Spacing (mm)	Contacts		Power Rating		Number of Columns	Column Pitch (mm)	Module Width Along Card Edge (mm)	Power Module Part Numbers	
	Total	Per Column	Amps per Contact	Amps per Module				Backplane/Midplane	Daughter Card
								Vertical Receptacle	Right-Angle Header
20	2	1	40	80	2	6	12	10028916-4554P00LF	10028918-001LF
20	2	1	40	80	2	6	12	10028916-5555P00LF	10028918-001LF
20	4	2	20	80	2	6	12	10028916-4444P00LF	10028917-001LF
20	4	2	20	80	2	6	12	10028916-4455P00LF	10028917-001LF
20	4	2	20	80	2	6	12	10028916-4554P00LF	10028917-001LF
20	4	2	20	80	2	6	12	10028916-4555P00LF	10028917-001LF
20	4	2	20	80	2	6	12	10028916-5554P00LF	10028917-001LF
20	4	2	20	80	2	6	12	10028916-5555P00LF	10028917-001LF
17	4	2	20	80	2	6	12	10028916-4444P00LF	10073379-001LF
17	4	2	20	80	2	6	12	10028916-4455P00LF	10073379-001LF
17	4	2	20	80	2	6	12	10028916-4554P00LF	10073379-001LF
17	4	2	20	80	2	6	12	10028916-4555P00LF	10073379-001LF
17	4	2	20	80	2	6	12	10028916-5554P00LF	10073379-001LF
17	4	2	20	80	2	6	12	10028916-5555P00LF	10073379-001LF
17	6	2	20	120	3	6	18	10061290-554555PLF	10061289-001LF
17	6	2	20	120	3	6	18	10061290-555444PLF	10061289-001LF
17	6	2	20	120	3	6	18	10061290-545555PLF	10061289-001LF

Hard Metric Coplanar Power Modules									
Minimum Card Slot Spacing (mm)	Contacts		Power Rating		Number of Columns	Column Pitch (mm)	Module Width Along Card Edge (mm)	Power Module Part Numbers	
	Total	Per Column	Amps per Contact	Amps per Module				Coplanar	Daughter Card
								Right -Angle Receptacle	Right -Angle Header
20	2	1	40	80	2	6	12	10124620-4554P00LF	10028918-001LF
20	2	1	40	80	2	6	12	10124620-5555P00LF	10028918-001LF
20	4	2	20	80	2	6	12	10124620-4444P00LF	10028917-001LF
20	4	2	20	80	2	6	12	10124620-4455P00LF	10028917-001LF
20	4	2	20	80	2	6	12	10124620-4554P00LF	10028917-001LF
20	4	2	20	80	2	6	12	10124620-4555P00LF	10028917-001LF
20	4	2	20	80	2	6	12	10124620-5555P00LF	10028917-001LF
17	4	2	20	80	2	6	12	10124620-4444P00LF	10073379-001LF
17	4	2	20	80	2	6	12	10124620-4455P00LF	10073379-001LF
17	4	2	20	80	2	6	12	10124620-4554P00LF	10073379-001LF
17	4	2	20	80	2	6	12	10124620-4555P00LF	10073379-001LF
17	4	2	20	80	2	6	12	10124620-5554P00LF	10073379-001LF
17	4	2	20	80	2	6	12	10124620-5555P00LF	10073379-001LF
17	6	2	20	120	3	6	18	10061290-554555PLF	10061289-001LF
17	6	2	20	120	3	6	18	10061290-555444PLF	10061289-001LF
17	6	2	20	120	3	6	18	10061290-545555PLF	10061289-001LF

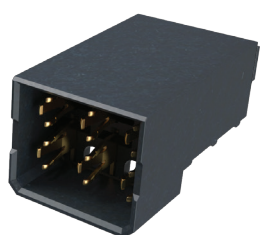

Right Angle Header

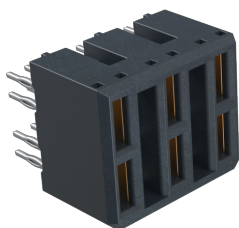

Vertical Receptacle

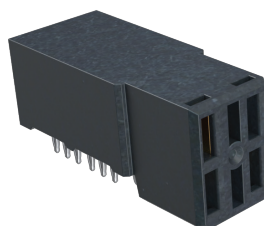

Right Angle Receptacle

MECHANICAL GUIDANCE MODULES

Mechanical guidance modules assure proper connector alignment prior to connector engagement and are suitable for backplane, coplanar or orthogonal midplane applications in Hard Metric environments.

Modules fitting 20.0mm slot pitch complement AirMax® 4-pair or 5-pair modules or ZipLine® 6-pair signal modules.

Modules fitting 17.0mm slot pitch complement AirMax® 3-pair signal modules or can be used with taller signal modules to provide more clearance for airflow.

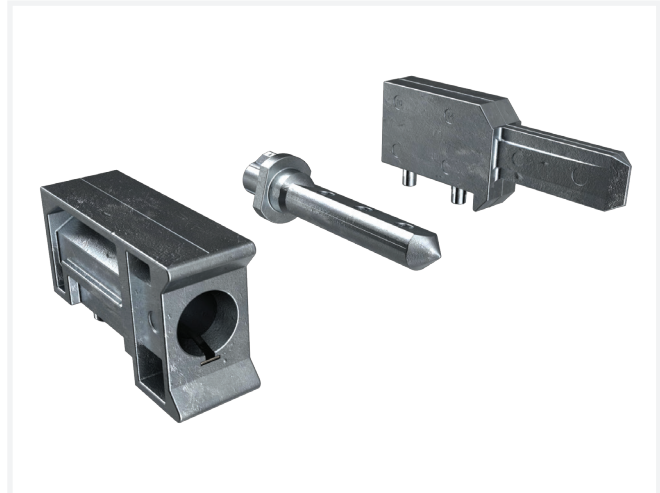

TARGET MARKETS



FEATURES

- Rugged metal components are fastened to boards with screws
- 7.5mm guide blades carry maximum weight in small space
- Free standing guidance components
- 10.2mm modules have guidance, coding, and ESD clips
- Hardware applications

BENEFITS

- Provides mechanically robust guidance
- Assures compatibility with any Hard Metric signal connectors
- Optimizes board edge real estate
- Maximizes design flexibility
- Enables board polarization and grounding
- Flexible design supports right angle and coplanar applications

y	Key Angle
1	0°
2	45°
3	90°
4	135°
5	180°
6	215°
7	270°
8	315°
9	no key

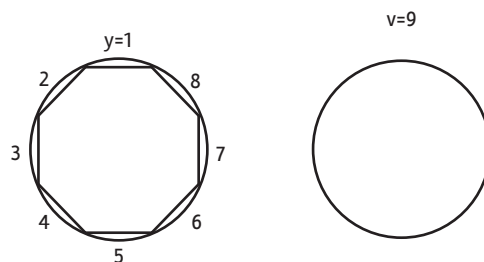

* For backplane guide pin modules, “xx” is dedicated by the backplane thickness. Replace with code from product drawing. Reference the product drawing for additional information.
 * For right-angle guide modules, “x” = 1 with ESD clip; “x” = 0 without ESD clip. “y” designates the keying angle option. Reference the product drawing for additional information.

PART NUMBERS

BLADE-STYLE BACKPLANE/MIDPLANE GUIDE MODULES –NO KEYING OR ESD OPTIONS

Application	Minimum Card Slot Spacing (mm)	Guide Module Width (mm)	Guide Pin Length (mm)	Guide Pin Thread Style	Guide Module Part Numbers	
					Backplane/ Midplane	Daughter Card
					Guide Pin	Right-Angle Guide Module
Backplane Guide Blade	20	7.2	18.3	External threads	10037915-101LF	10037909-101LF
	20	7.2	25.3	External threads	10037908-101LF	10037909-101LF
	20	7.2	25.3	Internal threads	10066832-101LF	10037909-101LF
	17	7.2	25.3	External threads	10045368-101LF	10045367-101LF
	17	7.2	21.6	Internal threads	10101902-101LF	10045367-101LF

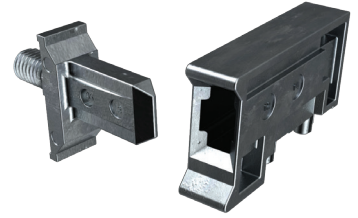

Backplane
(No key or ESD option)

**For inverse coplanar applications*

BLADE-STYLE BACKPLANE/MIDPLANE GUIDE MODULES –WITH KEYING AND ESD OPTIONS

Application	Minimum Card Slot Spacing (mm)	Guide Module Width (mm)	Guide Pin Length (mm)	Guide Pin Thread Style	Guide Module Part Numbers	
					Backplane/ Midplane	Daughter Card
					Guide Pin	Right-Angle Guide Module
Backplane Guide Pin	20	10.8	32	External threads	10037910-1xxLF	10037912-1xyLF
	20	10.8	32	Internal threads	10037911-1xxLF	10037912-1xyLF
	20	10.8	32	External threads	10037910-104LF	10130609-104LF
	20	10.8	32	Internal threads	10037911-104LF	10130609-104LF
	20	10.8	40.5	Internal threads	10120051-1xxLF	10037912-1xyLF
	17	10.8	32	External threads	10037910-1xxLF	10045597-1xyLF
	17	10.8	32	Internal threads	10037911-1xxLF	10045597-1xyLF
	17	10.8	40.5	Internal threads	10120051-1xxLF	10045597-1xyLF

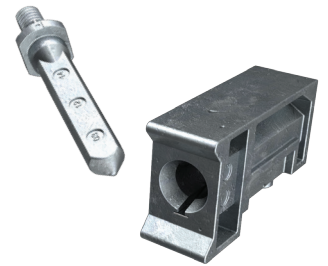

Backplane (With key)

COPLANAR GUIDE MODULES –NO KEYING OR ESD OPTIONS

Application	Minimum Spacing (mm)	Guide Width (mm)	Guide Length (mm)	Guide Module Part Numbers	
				Guide Pin	Right-Angle Guide Module
Coplanar Guide Blade	20	7.2	25.3	10044314-101LF	10037909-101LF
	17	7.2	25.3	10045588-101LF	10045367-101LF



Coplanar (No key or ESD option)

COPLANAR GUIDE MODULES –NO KEYING OR ESD OPTIONS

Application	Minimum Spacing (mm)	Guide Width (mm)	Guide Length (mm)	Guide Module Part Numbers	
				Guide Pin	Right-Angle Guide Module
Coplanar Guide Blade	20	10.8	29.9	10044366-10yLF	10037912-1xyLF
	17	10.8	29.9	10045509-10yLF	10045597-1xyLF

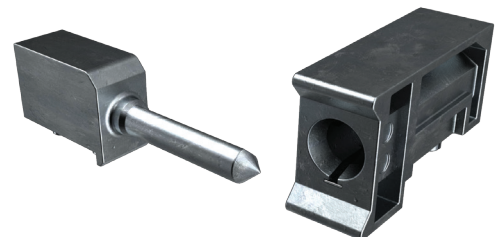

Coplanar (With key)

PART NUMBERS

AirMax VS2®/VSe® APPLICATION TOOLING

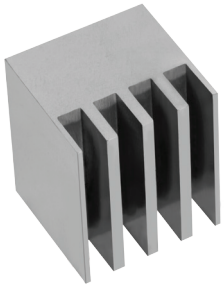

Insertion Tool

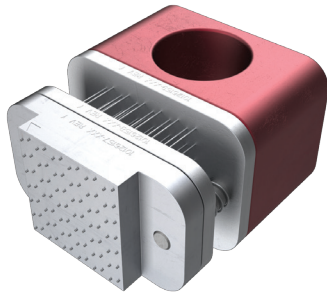

Vertical and Right Angle Header
Removal Tool

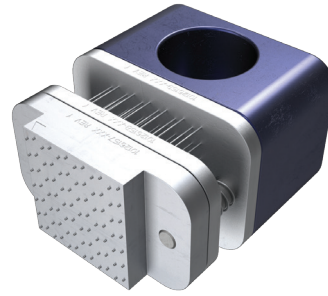

Right Angle Receptacle
Removal Tool

AirMax VS2®, VSe® Insertion Tooling						
Application Tool Part Numbers			2.0mm Column Pitch			
Pairs	Columns	Differential Pairs	Mating Connector System			
			Vertical Header	Vertical Receptacle	Right Angle Header	Right Angle Receptacle
3	6	18	10054653-306	430341	Flat Rock, No Tool	Flat Rock, No Tool
	8	24	10054653-308	430346	Flat Rock, No Tool	Flat Rock, No Tool
	10	30	10054653-310	430354	Flat Rock, No Tool	Flat Rock, No Tool
4	6	24	10054653-406	10062009	Flat Rock, No Tool	Flat Rock, No Tool
	8	32	10054653-408	10062008	Flat Rock, No Tool	Flat Rock, No Tool
	10	40	10054653-410	10062007	Flat Rock, No Tool	Flat Rock, No Tool
5	6	30	10054653-506	-	Flat Rock, No Tool	Flat Rock, No Tool
	8	40	10054653-508	430339	Flat Rock, No Tool	Flat Rock, No Tool
	10	50	10054653-510	430278	Flat Rock, No Tool	Flat Rock, No Tool

AirMax VS2®, VSe® Removal Tooling						
Application Tool Part Numbers			2.0mm Column Pitch			
Pairs	Columns	Differential Pairs	Mating Connector System			
			Vertical Header	Vertical Receptacle	Right Angle Header	Right Angle Receptacle
3	6	18	10139448-001	430341	10139457-001	10139466-001
	8	24	10139449-001	430346	10139458-001	10139467-001
	10	30	10139450-001	430354	10139459-001	10139468-001
4	6	24	10139451-001	10062009	10139460-001	10139469-001
	8	32	10139452-001	10062008	10139461-001	10139470-001
	10	40	10139453-001	10062007	10139462-001	10139471-001
5	6	30	10139454-001	-	10139463-001	10139472-001
	8	40	10139455-001	430339	10139464-001	10139473-001
	10	50	10139456-001	430278	10139465-001	10139474-001

PART NUMBERS

AirMax VS® APPLICATION TOOLING

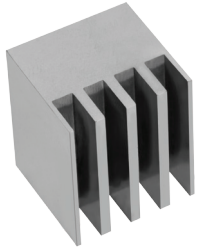

Insertion Tool

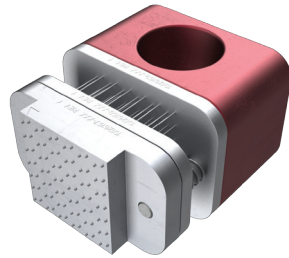

Vertical and Right Angle Header Removal Tool

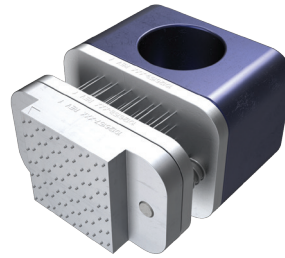

Right Angle Receptacle Removal Tool

AirMax VS® Insertion Tooling						
Application Tool Part Numbers			2.0mm Column Pitch			
Pairs	Columns	Differential Pairs	Mating Connector System			
			Vertical Header	Vertical Receptacle	Right Angle Header	Right Angle Receptacle
3	6	18	10055602-101	430324	430325	10058127
	8	24	10055602-102	430344	430343	-
	10	30	10055602-103	430352	430351	10066103
4	6	24	10055306-101	430398	430395	-
	8	32	10055306-102	430397	430394	10064163
	10	40	10055306-103	430396	430393	10058126
5	6	30	10055141-101	-	-	-
	8	40	10055141-102	430327	430326	10050658
	10	50	10055141-103	430277	430276	10041881

AirMax VS® Removal Tooling						
Application Tool Part Numbers			2.0mm Column Pitch			
Pairs	Columns	Differential Pairs	Mating Connector System			
			Vertical Header	Vertical Receptacle	Right Angle Header	Right Angle Receptacle
3	6	18	430340	430341	430340	430341
	8	24	430345	430346	430345	430346
	10	30	430353	430354	430353	430354
4	6	24	10062006	10062009	10062006	10062009
	8	32	10062005	10062008	10062005	10062008
	10	40	10062004	10062007	10062004	10062007
5	6	30	-	-	-	-
	8	40	430336	430339	430336	430339
	10	50	430289	430278	430289	430278

PART NUMBERS

AirMax VS2® 2PAIR APPLICATION TOOLING

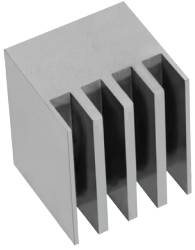

Insertion Tool

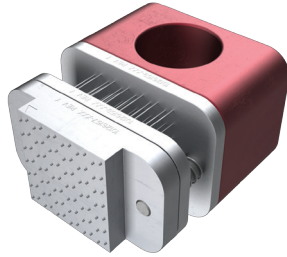

Vertical and Right Angle Header
Removal Tool

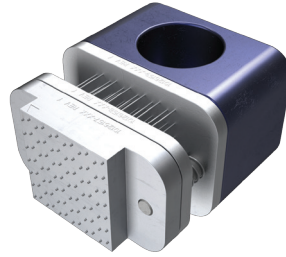

Right Angle Receptacle
Removal Tool

AirMax VS2® 2Pair Insertion Tooling				
Application Tool Part Numbers			1.9mm Column Pitch	
Pairs	Columns	Differential Pairs	Mating Connector System	
			Vertical Header	Vertical Receptacle
2	6	18	10140598-206	Flat Rock, No Tool
	8	24	10140598-208	Flat Rock, No Tool
	10	30	10140598-210	Flat Rock, No Tool

AirMax VS2® 2Pair Removal Tooling				
Application Tool Part Numbers			1.9mm Column Pitch	
Pairs	Columns	Differential Pairs	Mating Connector System	
			Vertical Header	Vertical Receptacle
2	6	18	10140599-001	10140602-001
	8	24	10140600-001	10140603-001
	10	30	10140601-002	10140604-001

Amphenol FCI

www.fci.com

BPLAIRMFAM017EA4