	TYPE	PRODUCT SPECIFICATION		NUMBER	GS-12-015
	TITLE			PAGE	REVISION
72476, 72477, 74894, & 74896 Type Metral 4-Row Unshielded Cable Connectors			1 of 28	D	
			AUTHORIZED BY	DATE	
			J. R. Volstorf	25-Apr-06	
			CLASSIFICATION		
			UNRESTRICTED		

## CONTENTS

1.	PURPOSE.....	4
2.	SCOPE.....	4
3.	GENERAL.....	4
	3.1. Design and Construction .....	4
	3.2. Workmanship.....	4
	3.3. Usage .....	4
	3.4. Visual.....	4
4.	PRODUCT DESCRIPTIONS.....	5
	4.1. 72476 type 4-row Metral™ Unshielded Connector .....	5
	4.2. 72477 type 4-row Metral™ Unshielded Connector .....	6
	4.3. 74894 type 4-row Metral™ Unshielded Connector .....	6
	4.4. 74896 type 4-row Metral™ Unshielded Connector .....	6
5.	REQUIREMENTS .....	7
	5.1. Qualification .....	7
	5.2. Material.....	7
	5.2.1. Metallic Parts .....	7
	5.2.2. Plastic Parts .....	7
	5.3. Finish.....	7
	5.3.1. Metallic Parts.....	7
	5.3.2. Plastic Parts .....	7
6.	ELECTRICAL CHARACTERISTICS .....	8
	6.1. Connector Contact Resistance .....	8
	6.2. Current Carrying Capacity .....	8
	6.3. Insulation Resistance.....	8
	6.4. Dielectric Withstanding Voltage .....	8
7.	MECHANICAL CHARACTERISTICS.....	8
	7.1. Mating Force.....	8
	7.2. Unmating Force .....	8
	7.3. Contact Normal Force on Pin .....	8
	7.4. Connector IDC Termination Retention ( Axial ).....	9
	7.5. Connector IDC Termination Retention ( 90° ).....	9
	7.6. Cover Retention on Connector .....	10
	7.7. Latch Retention .....	10
	7.8. Unlatching Mechanism .....	10
	7.9. Cable Clamp Tests .....	11
	7.9.1. Robustness.....	11
	7.9.2. Resistance to Cable Rotation .....	11
	7.9.3. Resistance to Cable Pull.....	11
	7.9.4. Resistance to Cable Torsion.....	11
	7.10. Insulator Retention in Covers.....	11

	TYPE	NUMBER	
	<b>PRODUCT SPECIFICATION</b>		<b>GS-12-015</b>
TITLE 72476, 72477, 74894, & 74896 Type Metral 4-Row Unshielded Cable Connectors		PAGE	REVISION
		2 of 28	D
		AUTHORIZED BY	DATE
		J. R. Volstorf	25-Apr-06
		CLASSIFICATION <b>UNRESTRICTED</b>	

8. ENVIRONMENTAL CONDITIONS ..... 12

8.1. Thermal Age ..... 12

8.1.1. For Test Groups 1 - 3 ..... 12

8.1.2. For Test Groups A, B, C, D, E, F, & G ..... 13

8.1.3. For Test Groups 4-5 ..... 13

8.1.4. For Test Groups 32 ..... 13

8.2. Mixed Flowing Gas ..... 14

8.2.1. Battelle II + SO<sub>2</sub> - Central Office ..... 14

8.2.2. Industrial Corrosion Ke Test - Central Office ..... 15

8.2.3. Industrial Corrosion Ke Test - Uncontrolled Environment ..... 15

8.3. High Humidity Endurance ..... 16

8.4. Thermal Shock - Climatic Sequence ..... 16

8.5. Vibration ..... 17

8.6. Vibration - Mechanical Shock ..... 17

8.6.1. Central Office Environment - IEC ..... 17

8.6.2. Central Office Environment - Bellcore ..... 18

8.7. Thermal Shock - Moisture Resistance ..... 18

8.7.1. Central Office Environment - Bellcore ..... 18

8.7.2. Uncontrolled Environment - Bellcore ..... 19

9. QUALITY ASSURANCE PROVISIONS ..... 19

9.1. Equipment Calibration ..... 19

9.2. Inspection Conditions ..... 19

9.3. Sample Quantity and Description ..... 19

9.4. Acceptance ..... 25

9.5. Qualification Testing ..... 25

9.6. Requalification Testing ..... 25

10. NOTES ..... 25

11. REFERENCE DOCUMENTS ..... 26

11.1. FCI Documents ..... 26

11.1.1. Product Drawings ..... 26

11.1.2. Process Specifications ..... 26

11.2. Other Standards and Specifications ..... 27

11.3. Lab Reports - Supporting Data ..... 27

12. EQUIVALENT QUALIFICATION TESTING ..... 27



	TYPE <b>PRODUCT SPECIFICATION</b>	NUMBER <b>GS-12-015</b>	
	TITLE 72476, 72477, 74894, & 74896 Type Metral 4-Row Unshielded Cable Connectors	PAGE 3 of 28	REVISION D
AUTHORIZED BY J. R. Volstorf		DATE 25-Apr-06	
CLASSIFICATION <b>UNRESTRICTED</b>			

Figure 1	4x6 Unshielded Connector .....	5
Figure 2	4x12 Unshielded Connector .....	6
Figure 3	Axial Contact Retention .....	9
Figure 4	90 Deg. Contact Retention .....	9
Figure 5	Cover Retention .....	10
Figure 6	Insulator Retention in Covers .....	11
Table 1 - Test Matrix: Except IDC only Tests .....		20
Table 2 - Test Matrix: Except IDC only Tests - Continued.....		21
Table 3 - Test Matrix: Except IDC only Tests - Continued.....		22
Table 4 - Test Matrix: Except IDC only Tests - Continued.....		23
Table 5 - Test Matrix: IDC only Tests .....		24

	TYPE	PRODUCT SPECIFICATION		NUMBER	GS-12-015
	TITLE			PAGE	REVISION
72476, 72477, 74894, & 74896 Type Metral 4-Row Unshielded Cable Connectors			4 of 28	D	
			AUTHORIZED BY	DATE	
			J. R. Volstorf	25-Apr-06	
			CLASSIFICATION		
			UNRESTRICTED		

1. **PURPOSE**

This specification defines the performance, test, quality, and reliability requirements for the 72476-X0Y and 74894-NNN 4x6 and the 72477-X0Y and 74896-NNN 4x12 Unshielded Cable Connectors.

2. **SCOPE**

This specification is applicable to qualification testing of the 72476, 72477, 74894 and 74896 type Cable Connectors used in conjunction with standard 4-Row Metral™ Unshielded Headers.

3. **GENERAL**

3.1. **Design and Construction**

Connectors, Covers and Headers shall be of the design, construction and physical dimensions specified on the applicable product drawings. The cable connector and header shall be capable of mating without any degradation in performance.

3.2. **Workmanship**

Workmanship shall be of a level that indicates controlled conditions of manufacture such that subsequent operations, functionality and performance are not degraded.

3.3. **Usage**

The connectors and headers covered by this instruction are intended for use in a wide variety of environments and are designed to meet the conditions specified in Bellcore GR-1217-CORE.

**Banned/Restricted Substances**

All product where the part number ends in 'LF' meet the European Union directives and other country regulations as described in GS-22-008. The part numbers that do not end in 'LF' meet all regulations except for Pb in SnPb plating.

**Manufacturing Processability**

All products covered by this specification will not withstand exposure to convection, infra-red or vapor phase reflow ovens. Do not heat this product above 110°C.

3.4. **Visual**

Visual examinations shall be performed with a magnification of up to 10x. (8 to 10x recommended)

	TYPE	NUMBER	
	<b>PRODUCT SPECIFICATION</b>	<b>GS-12-015</b>	
TITLE 72476, 72477, 74894, & 74896 Type Metral 4-Row Unshielded Cable Connectors	PAGE	REVISION	
	5 of 28	D	
	AUTHORIZED BY	DATE	
	J. R. Volstorf	25-Apr-06	
	CLASSIFICATION		
	UNRESTRICTED		

#### 4. PRODUCT DESCRIPTIONS

##### 4.1. 72476 type 4-row Metral™ Unshielded Connector

This connector is a 4x6 2mm pitch cable connector with IDC type contacts. The connectors have the following variations.

as 72476-wxy1 where  
“w” specifies the plating on the separable contact  
w = 1 , for 0.8um Gold  
w = 2 , for 2.0um Gold  
w = 3 , for 1.3um Gold  
w = 9 , for 0.8um GXT  
“y” specifies the wire gage capacity  
y = 1 , for 26-24 gage wire  
y = 2 , for 30-28 gage wire

“x” specifies the latch finger type  
x = 1 , for cable diameters up to 7.0mm  
x = 2 , for cable diameters up to 11.0mm

**Figure 1 4x6 Unshielded Connector**

Product Number  
72476-w1y1

Product Number  
72476-w2y1

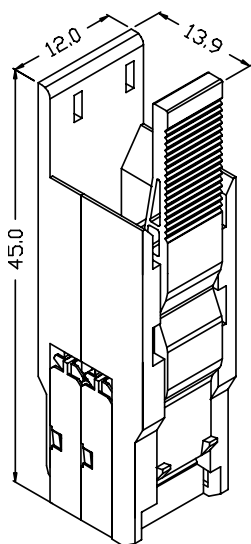

Standard Latch Finger

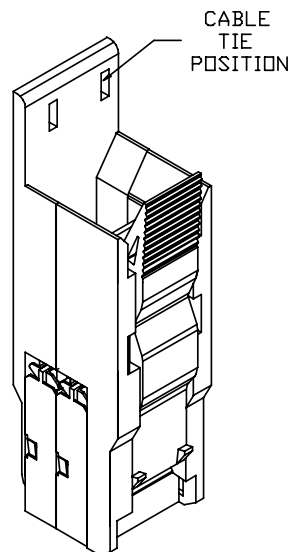

Short Latch Finger

The difference between the standard latch finger ( x = 1 ) and the short latch finger ( x = 2 ) is that the standard latch stands above the cable tie and is easier to access but thus restricts the maximum diameter cable that can be used. In certain cases the use of multiple cables or the stripping of the cable jacket above the cable tie area of the connector will allow the user to overcome some restrictions.

	TYPE	PRODUCT SPECIFICATION		NUMBER	GS-12-015			
	TITLE	72476, 72477, 74894, & 74896 Type Metral 4-Row Unshielded Cable Connectors			PAGE	6 of 28	REVISION	D
				AUTHORIZED BY	J. R. Volstorf		DATE	25-Apr-06
				CLASSIFICATION	UNRESTRICTED			

**4.2. 72477 type 4-row Metral™ Unshielded Connector**

This connector is a 4x12 2mm pitch cable connector with IDC type contacts. The connectors have the same variations as the 72476 types and adapt to slightly larger cables .

as 72477-wxy1 where  
 x = 1 , for cable diameters up to 9.5mm  
 x = 2 , for cable diameters up to 11.5mm

**Figure 2 4x12 Unshielded Connector**

Product Number	Product Number
72477-w1y1	72477-w2y1

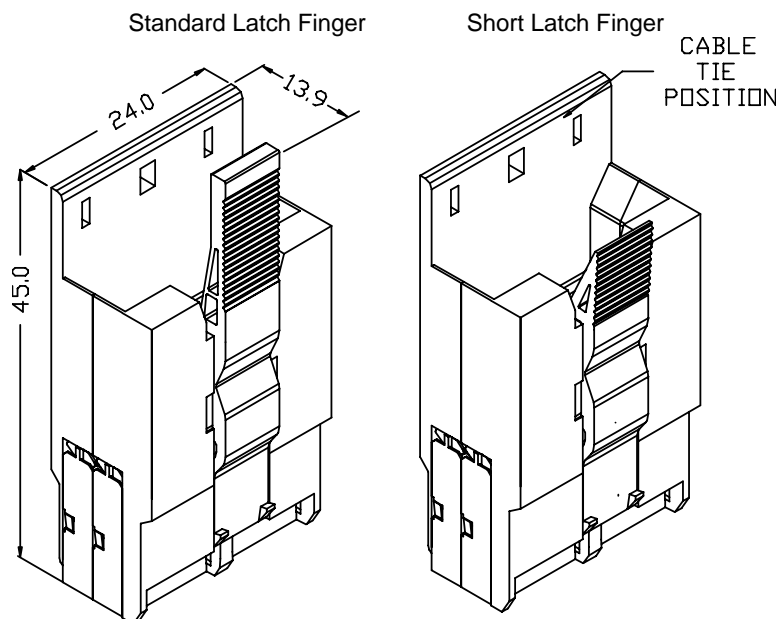

**4.3. 74894 type 4-row Metral™ Unshielded Connector**

This connector is a 4x6 2mm pitch cable connector with IDC type contacts. The connectors are basically the same as the 72476 types but have special variations. These variations may include selective loaded contacts, dimensional or color variations of the standard molded parts, special plating on the contacts, addition parts and/or special markings. Due to the possible complexity of the variations, there is no numbering scheme to define the variations. The differences compared to standard product can only be determined by examining the product drawings.

**4.4. 74896 type 4-row Metral™ Unshielded Connector**

This connector is a 4x12 2mm pitch cable connector with IDC type contacts. The connectors are basically the same as the 72477 types but have special variations. These variations may include selective loaded contacts, dimensional or color variations of the standard molded parts, special plating on the contacts, addition parts and/or special markings. Due to the possible complexity of the variations, there is no numbering scheme to define the variations. The differences compared to standard product can only be determined by examining the product drawings.

	TYPE	PRODUCT SPECIFICATION		NUMBER	GS-12-015
	TITLE		PAGE	REVISION	
72476, 72477, 74894, & 74896 Type Metral 4-Row Unshielded Cable Connectors		7 of 28	D		
		AUTHORIZED BY	DATE		
		J. R. Volstorf	25-Apr-06		
		CLASSIFICATION			
		UNRESTRICTED			

## 5. REQUIREMENTS

### 5.1. Qualification

Connectors furnished under this specification shall be capable of meeting the qualification test requirements specified herein.

### 5.2. Material

#### 5.2.1. Metallic Parts

Contact, Connector: Phosphor Bronze Strip, C51200, 0.0080 ±0.0002 inch thick, UTS of 69,000 to 84,000 psi

#### 5.2.2. Plastic Parts

Insulator: 612 Polyamide, 30% GFR, Flame retardant UL94V-0, Natural

Covers: 612 Polyamide, 30% GFR, Flame retardant UL94V-0, Natural

Keys: 612 Polyamide, 30% GFR, Flame retardant UL94V-0, Natural

Latch Fingers: Ultem 1010, Flame retardant UL94V-0, Black

### 5.3. Finish

#### 5.3.1. Metallic Parts

Contact, Connector:

IDC Dimples:

If part number does not end in 'LF'

93-7 (Sn-Pb) Solder, 1.3 micron min., 5.1 micron max.

If part number does end in 'LF'

Sn ( lead free ) Solder, 1.3 micron min., 5.1 micron max.

Separable Contacts:

- (a) 0.8 micron GXT/1.3 micron nickel
- (b) 0.8 micron Gold/1.3 micron nickel
- (c) 1.3 micron Gold/1.3 micron nickel
- (d) 2.0 micron Gold/1.3 micron nickel

#### 5.3.2. Plastic Parts

No finish on plastic parts

	TYPE	PRODUCT SPECIFICATION		NUMBER	GS-12-015	
	TITLE			PAGE	REVISION	
72476, 72477, 74894, & 74896 Type Metral 4-Row Unshielded Cable Connectors			8 of 28		D	
			AUTHORIZED BY		DATE	
			J. R. Volstorf		25-Apr-06	
			CLASSIFICATION			
			UNRESTRICTED			

## 6. ELECTRICAL CHARACTERISTICS

### 6.1. Connector Contact Resistance

The bulk resistance of the contact shall be measured in accordance with EIA-364-23 at the following conditions.

Test voltage - 20 millivolts DC maximum open circuit

Test current - Not to exceed 100 milliamperes

### 6.2. Current Carrying Capacity

The current carrying capacity of a mated signal pair is rated at 1 ampere with current applied to all contacts when measured in accordance with EIA-364-70. Temperature rise should not exceed 30° C.

### 6.3. Insulation Resistance

The insulation resistance of unmated connectors and headers shall be no less than 5000 megohms initially and no less than 1000 megohms after environmental exposure when measure in accordance with EIA-364-21 at the following conditions.

Test voltage: 200 VDC

Electrification time: 2 minutes

Points of measurement: Between adjacent contacts and pins.

### 6.4. Dielectric Withstanding Voltage

There shall be no evidence of arc-over, insulation breakdown or excessive leakage current (>1 milliampere) when unmated connectors and headers are tested in accordance with EIA-364-20 at the following conditions.

Test voltage: 1000 VDC or 1000 VAC peak-to-peak

Test Duration: 60 seconds

Test condition: 1 atm

Points of measurement: Between adjacent contacts and pins

## 7. MECHANICAL CHARACTERISTICS

### 7.1. Mating Force

The total force to mate the connector to the header shall not exceed 1.0 Newton times the number of contacts, when measured in accordance with EIA-364-13

### 7.2. Unmating Force

The total force to withdraw the connector from the header shall not exceed 1.13 Newton times the number of contacts, when measured in accordance with EIA-364-13. The minimum force shall exceed 0.2 Newton times the number of contacts, when measures in accordance with EIA-364-13.

### 7.3. Contact Normal Force on Pin

The contact normal force on the pin shall be no less than 50 grams, when measured in accordance with EIA-364-04



	TYPE <b>PRODUCT SPECIFICATION</b>	NUMBER <b>GS-12-015</b>	
	TITLE 72476, 72477, 74894, & 74896 Type Metral 4-Row Unshielded Cable Connectors	PAGE 9 of 28	REVISION D
	AUTHORIZED BY J. R. Volstorf	DATE 25-Apr-06	
	CLASSIFICATION <b>UNRESTRICTED</b>		

**7.4. Connector IDC Termination Retention ( Axial )**

There shall be no loosening of the IDC termination or the contact in the insulator or damage to the IDC termination, contact or connector when a 13.4 Newton axial force is applied to a wire, in accordance with GES-20-002 except for the two end positions in the connector sub-assembly where the contact latch is exposed. These two positions must meet a 8.9 Newton axial force. Minimum sample size is 10 contacts per specimen.

Figure 3 Axial Contact Retention

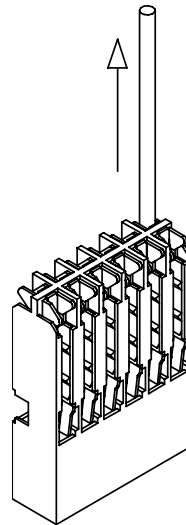

**Connector IDC Termination Retention ( 90° )**

There shall be no loosening of the IDC termination or the contact in the insulator or damage to the IDC termination, contact or connector when a 8.9 Newton force is applied at a 90° angle to a wire, in accordance with GES-20-002. Minimum sample size is 10 contacts per specimen.

Figure 4 90 Deg. Contact Retention

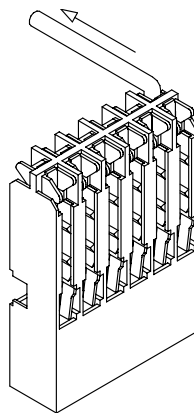

	TYPE <b>PRODUCT SPECIFICATION</b>	NUMBER <b>GS-12-015</b>	
	TITLE 72476, 72477, 74894, & 74896 Type Metral 4-Row Unshielded Cable Connectors	PAGE 10 of 28	REVISION D
	AUTHORIZED BY J. R. Volstorf	DATE 25-Apr-06	
	CLASSIFICATION <b>UNRESTRICTED</b>		

**7.6. Cover Retention on Connector**

When the cover are assembled to the connector sub-assemblies, the assembly shall withstand the specified load. The press fit plastic studs of the latch side cover shall not be broken or cracked and the plastic of the covers shall not be broken or cracked nor shall the two parts unmate. The minimum retention force is 20 Newtons for the 72476 and 74894 type connectors and 30 Newtons for the 72477 and 74896 type connectors.

Figure 5 Cover Retention

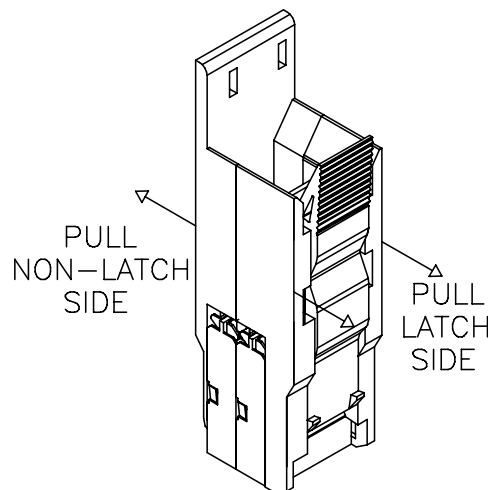

**7.7. Latch Retention**

When mated with standard Metral 4-row unshielded headers, the cover and cable connector assembly shall withstand a 44.5N (10 pound) axial pull force applied against the cover latching details.

**7.8. Unlatching Mechanism**

The latch finger used to retain the cable assembly in the header shall withstand 200 insertion and extraction cycles without cracking or breaking.

	TYPE <b>PRODUCT SPECIFICATION</b>	NUMBER <b>GS-12-015</b>	
	TITLE 72476, 72477, 74894, & 74896 Type Metral 4-Row Unshielded Cable Connectors	PAGE 11 of 28	REVISION D
	AUTHORIZED BY J. R. Volstorf	DATE 25-Apr-06	
	CLASSIFICATION <b>UNRESTRICTED</b>		

**7.9. Cable Clamp Tests**

Minimum sample size is 10 one ended cable assemblies. Prepare samples per GES-20-003.

**7.9.1. Robustness**

Test per IEC 512-9, test 17a. The length of the cable from the cable strain relief to the free end of the cable shall be  $20 \pm 4$  cm. Clamp specimens to base of Instron or equivalent pull test machine. Apply force equal to 2.23 N ( 1/2 lb.) per contact at a distance of 10 cm from cable strain relief during test. Perform the test cycle once. Visually inspect parts after testing per IEC 512-2, Test 1a.

**7.9.2. Resistance to Cable Rotation**

Test per IEC 512-9, test 17b. Clamp specimens in vise in vertical position. Secure cable at  $15 \pm 3$  cm from cable strain relief for rotation. Perform two rotations at  $5 \pm 2$  second cycles. Visually inspect parts after testing per IEC 512-2, Test 1a.

**7.9.3. Resistance to Cable Pull**

Test per IEC 512-9, test 17c. Clamp specimens to base of Instron or equivalent pull test machine. Apply force equal to 2.23 N ( 1/2 lb.) per contact at a distance of 10 cm from cable strain relief during test. Perform the test cycle once. Visually inspect parts after testing per IEC 512-2, Test 1a. The cable jacket shall not be pulled out of the cable tie.

**7.9.4. Resistance to Cable Torsion**

Test per IEC 512-9, test 17d. Clamp specimens to base of test machine. Apply torque required to rotate the cable 360 degrees at a distance of 10 cm from cable strain relief during test. Perform the test cycle once. Visually inspect parts after testing per IEC 512-2, Test 1a. The cable jacket shall not be pulled out of the cable tie.

**7.10. Insulator Retention in Covers**

The insulators shall be retained in the covers such that they withstand a 5 Newton per contact force between the covers and the insulators.

Figure 6 Insulator Retention in Covers

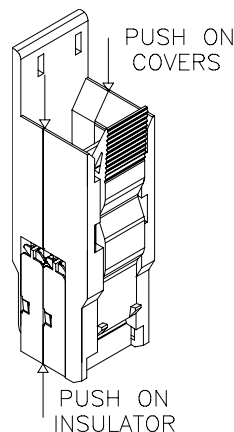

	TYPE	PRODUCT SPECIFICATION		NUMBER	GS-12-015		
	TITLE			PAGE	REVISION		
72476, 72477, 74894, & 74896 Type Metral 4-Row Unshielded Cable Connectors			12 of 28		D		
			AUTHORIZED BY		DATE		
			J. R. Volstorf		25-Apr-06		
			CLASSIFICATION				
			UNRESTRICTED				

## 8. ENVIRONMENTAL CONDITIONS

After exposure to the following environmental conditions in accordance with the specified test procedure and/or details, the product shall show no physical damage and shall meet the electrical and mechanical requirements in sections 6. and 7 as specified in "Table 1 - Test Sequences". Unless specified otherwise, product shall be mated during exposure.

### 8.1. Thermal Age

#### 8.1.1. For Test Groups 1 - 3

Mated connectors and headers must meet the requirement of Bellcore GR-1217-CORE and Lucent Technologies Specification X-20954 section 4.06a when tested per IEC 68-2-2, test Bd. A minimum of 100 contacts for product exposed mated and 50 contacts for product exposed unmated shall be measured for contact resistance in this test. Contact resistance shall not change by more than 5 milliohms. A minimum of 10 contacts of group 1 shall be measured for insulation resistance and dielectric withstanding voltage.

#### Test Plan:

1. Divide test groups into two sub-groups. The second sub-group shall consists of 2 samples and the first sub-group the remaining. One of the samples of the first sub-group of group 1 shall be reserved for the insulation resistance and dielectric withstanding voltage tests.
2. Mate all samples and measure mating force.
3. Measure contact resistance of both groups
4. Measure insulation resistance and dielectric withstanding voltage of group 1, sub-group 1
5. Unmate and mate the second group for a total of 100 wear cycles. Measure unmating force on first unmate.
6. Measure contact resistance of the second group
7. Unmate the second group
8. Expose both groups to 105° C for the first 42 days and 100° C thereafter for a total of 112 days.
9. Interrupt the exposure at 21, 42 and 75 days allowing 2 hours for the groups to recover to ambient. Mate the second group and measure contact resistance. Unmate the second group before continuing exposure.
10. After 112 days, remove both groups and allow 24 to 72 hours to recover to ambient. Mate the second group and measure contact resistance of both groups.
11. Measure insulation resistance and dielectric withstanding voltage of group 1, sub-group 1
12. Add one unmate and mate cycle to both groups and measure contact resistance. Measure unmating and mating forces.

	TYPE	PRODUCT SPECIFICATION		NUMBER	GS-12-015		
	TITLE			PAGE	REVISION		
72476, 72477, 74894, & 74896 Type Metral 4-Row Unshielded Cable Connectors			13 of 28	D			
			AUTHORIZED BY	DATE			
			J. R. Volstorf	25-Apr-06			
			CLASSIFICATION				
			UNRESTRICTED				

**8.1.2. For Test Groups A, B, C, D, E, F, & G**

The unmated connectors must meet the requirement of IEC 1076-4 and Lucent Technologies Specification X-20954 section 4.06a for the IDC only interface when tested per IEC 68-2-2, test Bd. The conditions of this test shall be considered meet if contacts with the same IDC dimples ( 72392-XYZ ) pass the same tests per product specification GES-12-086. Sample size is 80 minimum for all groups. Contact resistance shall not change by more than 1 milliohm.

Test Plan:

1. Measure contact resistance
2. Expose to 105° C for the first 42 days and 100° C thereafter for a total of 112 days.
3. Interrupt the exposure at 21, 42 and 75 days allowing 2 hours for recovery to ambient. Measure contact resistance.
4. After 112 days, remove product and allow 24 to 72 hours to recover to ambient, measure contact resistance

**8.1.3. For Test Groups 4-5**

Mated connectors and headers must meet the requirement of IEC 1076-4-110 ( Feb. 97 draft) and IEC 512-9b. A minimum of 30 contacts shall be measured for contact resistance in this test. Contact resistance shall not change by more than 5 milliohm. A minimum of 10 contacts of group 4 shall be measured for insulation resistance and dielectric withstanding voltage.

Test Plan:

1. Mate all samples
2. Measure contact resistance
3. Unmate and mate samples for a total of 100 wear cycles.
4. Measure contact resistance
5. Measure insulation resistance and dielectric withstanding voltage on sample of group 4.
6. Expose samples to 70° C under a 1 Amp load for 42 days
7. After 1000 hours, remove the samples and allow 1 hour min., 2 hours max. to recover to ambient. Measure contact resistance Measure insulation resistance and dielectric withstanding voltage on sample of group 4

**8.1.4. For Test Groups 32**

This is a specification for the thermal age of the plastic parts only

Test Plan:

1. Expose to 100°C ±5°C for 24 ±4 hours
2. After exposure remove product and allow 24 to 72 hours to recover to ambient.

	TYPE	PRODUCT SPECIFICATION		NUMBER	GS-12-015		
	TITLE	72476, 72477, 74894, & 74896 Type Metral 4-Row Unshielded Cable Connectors		PAGE	14 of 28	REVISION	D
				AUTHORIZED BY	J. R. Volstorf	DATE	25-Apr-06
				CLASSIFICATION	UNRESTRICTED		

## 8.2. Mixed Flowing Gas

### 8.2.1. Battelle II + SO<sub>2</sub> - Central Office

Mated connectors and headers must meet the requirements of Bellcore Gr-1217-CORE Section 9.1.3 for Battelle II + SO<sub>2</sub>. A minimum of 100 contacts shall be measured in this test. Contact resistance shall not change by more than 5 milliohms.

Test Plan:

1. Mate all samples
2. Measure contact resistance
3. Unmate and mate 99 times for a total of 100 wear cycles
4. Measure contact resistance
5. Expose connectors to MFG environment for a total of 20 days in the following sequence.
  - Expose unmated connectors and headers for 5 days
  - Remove from chamber, mate and measure contact resistance
  - Disconnect and expose for 5 more days
  - Remove from chamber, mate and measure contact resistance
  - Expose mated connectors and headers for 5 more days
  - Remove from chamber, unmate, mate and measure contact resistance.
  - Expose mated connectors and headers for 5 more days
  - Remove from chamber and measure contact resistance
6. Disturb the connection ( approximately 0.004 inches) and measure contact resistance.
7. Unmate and mate 97 times for a total of 200 wear cycles
8. Measure contact resistance.
9. Visually inspect connectors for excessive degradation.

	TYPE	PRODUCT SPECIFICATION		NUMBER	GS-12-015
	TITLE			PAGE	REVISION
72476, 72477, 74894, & 74896 Type Metral 4-Row Unshielded Cable Connectors			15 of 28	D	
			AUTHORIZED BY	DATE	
			J. R. Volstorf	25-Apr-06	
			CLASSIFICATION		
			UNRESTRICTED		

**8.2.2. Industrial Corrosion Ke Test - Central Office**

Mated connectors and headers must meet the requirements of IEC 68-2-60, test Ke (Method 1) and X-20954, Issue 2, Section 4.6.3.2. A minimum of 100 contacts shall be measured in this test. Contact resistance shall not change by more than 5 milliohms.

Test Plan:

1. Divide samples into two groups
2. Insert and measure contact resistance
3. Unmate and mate both groups 99 times for a total of 100 wear cycles
4. Measure contact resistance of both groups
5. Disconnect second group
6. Expose both groups to MFG environment for a total of 10 days.
7. Mate the second group and measure contact resistance of both groups.
8. Visually inspect connectors for excessive degradation.

**8.2.3. Industrial Corrosion Ke Test - Uncontrolled Environment**

Mated connectors and headers must meet the requirements of IEC 68-2-60, test Ke (Method 1) and X-20954, Issue 2, Section 4.6.3.2. A minimum of 100 contacts shall be measured in this test. Contact resistance shall not change by more than 5 milliohms. A minimum of 10 contacts shall be measured for insulation resistance and dielectric withstanding voltage.

Test Plan:

1. Divide samples into two sub-groups.
2. Insert and measure contact resistance. Measure insulation resistance and dielectric withstanding voltage on group 13.
3. Unmate and mate 99 times for a total of 100 wear cycles
4. Measure contact resistance.
5. Unmate second sub-group.
6. Expose all groups to MFG environment for a total of 21 days.
7. Remove from chamber and mate second sub-groups
8. Measure contact resistance of both sub-groups.
9. Measure insulation resistance and dielectric withstanding voltage on first sub-group of group 13.
10. Visually inspect connectors for excessive degradation.

	TYPE	PRODUCT SPECIFICATION		NUMBER	GS-12-015		
	TITLE	72476, 72477, 74894, & 74896 Type Metral 4-Row Unshielded Cable Connectors		PAGE	16 of 28	REVISION	D
				AUTHORIZED BY	J. R. Volstorf	DATE	25-Apr-06
				CLASSIFICATION	UNRESTRICTED		

### 8.3. High Humidity Endurance

Mated header and connector must meet the requirements of IEC 1076-4 when tested in accordance with IEC 68-2-3, test Ca. A minimum of 100 contacts shall be measured in this test for contact resistance. Contact resistance shall not change more than 5 milliohms in this test. A minimum of 10 contacts of group 6 shall be measured for insulation resistance and dielectric withstanding voltage.

Test Plan:

1. Measure mating and unmating forces.
2. All samples to be mated
3. Measure contact resistance.
4. Measure insulation resistance and dielectric withstanding voltage on group 6.
5. Expose all samples to 40° C/ 93%RH ( steady state ) for a total of 56 days at 60 VDC polarizing voltage.
6. Remove after 56 days
7. Between 1 and 2 hours after removal measure insulation resistance on group 6.
8. After 24 to 72 hours to recover to ambient, measure contact resistance. Measure dielectric withstanding voltage on group 6.
9. Measure mating and unmating forces.

### 8.4. Thermal Shock - Climatic Sequence

Mated headers and connectors must meet the requirements of IEC 68-2-14, test NA. A minimum of 100 contacts shall be measured in this test for contact resistance. Contact resistance shall not change by more than 5 milliohms. A minimum of 10 contacts of 'GXT' group shall be measured for insulation resistance and dielectric withstanding voltage.

Test:

1. Mate and measure contact resistance
2. Measure insulation resistance and dielectric withstanding voltage on group 15.
3. Measure mating and unmating forces
4. Expose connector to 5 cycles between -65°C and +125°C. The dwell time at each extreme should be 15 minutes and the temperature transition time should be less than 30 seconds.
5. Allow samples to recover for at least 1 hours and not more than 2 hours.
6. Measure contact resistance.
7. Measure insulation resistance and dielectric withstanding voltage on group 15.
8. Dry Heat: Expose connectors to 100°C for 16 hours (IEC 68-2-2, test Ba)
9. Measure insulation resistance during last hour of exposure.
10. Damp Heat: Expose to cyclic temperature/humidity (IEC 68-2-30, test Db). Upper Temperature 55°C. One 24 hour cycle
11. Cold: Transfer connectors immediately to -40°C for 16 hours
12. Damp Heat: Immediately transfer connectors to a 2nd damp heat cycle.
13. After 1 hour and less than 2 hours measure contact resistance. Measure insulation resistance and dielectric withstanding voltage on group 15.
14. Measure insertion/withdrawal forces.



	TYPE	PRODUCT SPECIFICATION		NUMBER	GS-12-015
	TITLE			PAGE	REVISION
72476, 72477, 74894, & 74896 Type Metral 4-Row Unshielded Cable Connectors			17 of 28	D	
			AUTHORIZED BY	DATE	
			J. R. Volstorf	25-Apr-06	
			CLASSIFICATION		
			UNRESTRICTED		

### 8.5. Vibration

Mated headers and connectors must meet the requirements of IEC 1076-4-110 (Feb 97 draft) & IEC512, test 6d. A minimum of 100 contacts shall be measured in this test for contact resistance. Contact resistance shall not change by more than 5 milliohms.

Test:

1. Mate and measure contact resistance
2. Vibration: Expose to vibration
  - Sine wave, 10 to 2000 Hz, 200m/s<sup>2</sup> over 58Hz (20g)
  - 2 hour each direction, 3 axis (15 min. cycle)
  - Monitor events > 1μs
3. Measure contact resistance.

### 8.6. Vibration - Mechanical Shock

#### 8.6.1. Central Office Environment - IEC

Mated headers and connectors must meet the requirements of tests listed. A minimum of 100 contacts shall be measured in this test for contact resistance. Contact resistance shall not change by more than 5 milliohms.

Test:

1. Mate and measure contact resistance
2. Vibration: Expose to vibration per IEC 68-2-6, Test Fc
  - Sine wave, 10 to 500 Hz, 98m/s<sup>2</sup> over 58Hz (10g)
  - 1 octave/min. 2 hour each direction, 3 axis (15 min. cycle)
  - Monitor events > 10ns
3. Measure contact resistance.
4. Mechanical Shock: Expose to shock per IEC 68-2-27, Test Ea
  - Half sine wave, 490m/s<sup>2</sup> (50g)
  - 11ms, 6 shocks each direction, 3 axis
  - Monitor events > 10ns
5. Measure contact resistance

	TYPE	NUMBER	
	<b>PRODUCT SPECIFICATION</b>		<b>GS-12-015</b>
TITLE 72476, 72477, 74894, & 74896 Type Metral 4-Row Unshielded Cable Connectors	PAGE	REVISION	
	18 of 28	D	
	AUTHORIZED BY	DATE	
	J. R. Volstorf	25-Apr-06	
	CLASSIFICATION		
	<b>UNRESTRICTED</b>		

### 8.6.2. Central Office Environment - Bellcore

Mated headers and connectors must meet the requirements of Bellcore GR-1217-CORE. A minimum of 100 contacts shall be measured in this test for contact resistance. Contact resistance shall not change by more than 10 milliohms. A minimum of 10 contacts shall be measured for insulation resistance and dielectric withstanding voltage.

Test:

1. Measure mating and unmating forces
2. Mate and measure contact resistance
3. Measure insulation resistance and dielectric withstanding voltage on group 20.
4. Unmate and mate for 98 wear cycles. Apply DUST. Measure contact resistance
5. Vibration: Expose all samples to vibration per EIA-364-TP28B, TC II  
10 to 500 Hz, @ 10g peak  
2 hour each direction, 3 axis  
Monitor events > 10ns
6. Measure contact resistance.
7. Mech. Shock: Expose all samples to shock per EIA-364-TP27B, TC 1  
30g half sine wave  
3 shocks each direction, 3 axis (18 shocks)  
Monitor events > 10ns
8. Measure contact resistance
9. Measure insulation resistance and dielectric withstanding voltage on group 20.
10. Measure mating and unmating forces.

### 8.7. Thermal Shock - Moisture Resistance

#### 8.7.1. Central Office Environment - Bellcore

Mated headers and connectors must meet the requirements of listed. A minimum of 100 contacts shall be measured in this test for contact resistance. Contact resistance shall not change by more than 10 milliohms. A minimum of 10 contacts shall be measured for insulation resistance and dielectric withstanding voltage.

Test:

1. Measure mating and unmating forces
2. Mate and measure contact resistance
3. Mate and measure insulation resistance and dielectric withstanding voltage on group 22.
4. Thermal Shock: Expose all samples to shock per EIA-364-TP32A, TC I  
-55°C to 85°C, 5 cycles, 30 minutes/cycle
5. Measure contact resistance.
6. On samples for contact resistance testing unmate and mate for 99 wear cycles. Apply DUST. Measure contact resistance
7. Moisture resistance: Expose all samples per EIA-364-TP31A, method III  
+25°C to 65°C, 50 cycles
8. Allow 24 hours for recovery
9. Measure contact resistance
10. Measure insulation resistance and dielectric withstanding voltage on group 22.
11. Measure mating and unmating forces.

	TYPE	PRODUCT SPECIFICATION		NUMBER	GS-12-015	
	TITLE			PAGE	REVISION	
72476, 72477, 74894, & 74896 Type Metral 4-Row Unshielded Cable Connectors			19 of 28	D		
			AUTHORIZED BY	DATE		
			J. R. Volstorf	25-Apr-06		
			CLASSIFICATION			
			UNRESTRICTED			

**8.7.2. Uncontrolled Environment - Bellcore**

Mated and headers and connectors must meet the requirements of listed. A minimum of 100 contacts shall be measured in this test for contact resistance. Contact resistance shall not change by more than 10 milliohms. A minimum of 10 contacts shall be measured for insulation resistance and dielectric withstanding voltage.

Test:

1. Measure mating and unmating forces
2. Mate and measure contact resistance
3. Mate and measure insulation resistance and dielectric withstanding voltage.
4. Thermal Shock: Expose all samples to shock per EIA-364-TP32A, TC II  
-65°C to 105°C, 5 cycles, 30 minutes/cycle
5. Measure contact resistance.
6. On samples for contact resistance testing unmate and mate for 99 wear cycles.  
Apply DUST. Measure contact resistance
7. Moisture resistance: Expose all samples per EIA-364-TP31A, method III  
+5°C to 85°C, 50 cycles
8. Allow 24 hours for recovery
9. Measure contact resistance
10. Measure insulation resistance and dielectric withstanding voltage.
11. Measure mating and unmating forces.

**9. QUALITY ASSURANCE PROVISIONS**

**9.1. Equipment Calibration**

All test equipment and inspection facilities used in the performance of any text shall be maintained in a calibration system in accordance with BUS-01-040.

**9.2. Inspection Conditions**

Unless otherwise specified herein, all inspections shall be performed under the following conditions:

- Temperature: 25° ± 5° C
- Relative humidity: 30% to 60%
- Barometric pressure: Local ambient

**9.3. Sample Quantity and Description**

The test sequence for the qualification testing of the connector and header and sample size are shown in Table 1. A minimum of ninety contacts will be selected equally from the connectors in each test group.

	TYPE	PRODUCT SPECIFICATION	NUMBER	GS-12-015
	TITLE	72476, 72477, 74894, & 74896 Type Metral 4-Row Unshielded Cable Connectors		PAGE
			AUTHORIZED BY	J. R. Volstorf
			REVISION	D
			DATE	25-Apr-06
			CLASSIFICATION	UNRESTRICTED

Table 1 - Test Matrix: Except IDC only Tests

		TEST GROUP							
		1	2	3	4	5	6	7	8
<b>QUANTITY OF CONNECTORS</b>									
72476-1XY 4X6 WITH 0.8um GOLD PLATING				6		4		4	
72476-2XY 4X6 WITH 2.0UM GOLD PLATING									
72476-3XY 4X6 WITH 1.3um GOLD PLATING									
72476-9XY 4X6 WITH 0.8um GXT PLATING		6	6		4		4		4
<b>QUANTITY OF HEADERS</b>									
70232-12Z 4x6 WITH 0.8um GOLD PLATING				6		4		4	
70232-51Z 4x6 WITH 1.3um GXT PLATING &			6						
70232-92Z 4x6 WITH 0.8um GXT PLATING		6			4		4		4
<b>TEST</b>	<b>PARA</b>	<b>TEST SEQUENCE</b>							
EXAMINATION OF PRODUCT	3.1	1,3	1,3	1,3	1,3	1,3	1,3	1,3	1,5
<b>ELECTRICAL CHARACTERISTICS</b>									
CONNECTOR CONTACT RESISTANCE	6.1	X	X	X	X	X	X	X	
CURRENT CARRYING CAPACITY	6.2								2
INSULATION RESISTANCE <sup>2</sup>	6.3	X	X	X	X	X	X	X	
DIELECTRIC WITHSTANDING VOLTAGE <sup>2</sup>	6.4	X	X	X	X	X	X	X	
<b>MECHANICAL CHARACTERISTICS</b>									
MATING FORCE <sup>1</sup>	7.1	X	X	X			X	X	
UNMATING FORCE <sup>1</sup>	7.2	X	X	X			X	X	
IDC RETENTION ( AXIAL )	7.4								
IDC RETENTION ( 90° )	7.5								
COVER RETENTION	7.6	4	4	4			4	4	3
LATCH RETENTION	7.7			5			5	5	4
UNLATCHING MECHANISM	7.8				4	4			
INSULATOR RETENTION IN COVERS	7.10	5	5	5	5	5	6	6	
<b>ENVIRONMENTAL CONDITIONS</b>									
THERMAL AGE <sup>1</sup> 100°C, 112 DAY	8.1.1	2	2	2					
THERMAL AGE 70°C, 1 AMP, 42 DAY	8.1.3				2	2			
H. HUMIDITY - 93%, 40°C FOR 56 DAYS	8.3						2	2	

1. Mating and unmating forces are to be measure in first and last steps of thermal age.
2. Insulation resistance and dielectric withstanding voltage are to be measured on different contacts.

	TYPE	PRODUCT SPECIFICATION	NUMBER	GS-12-015
	TITLE		PAGE	REVISION
72476, 72477, 74894, & 74896 Type Metral 4-Row Unshielded Cable Connectors		21 of 28		D
		AUTHORIZED BY	DATE	
		J. R. Volstorf	25-Apr-06	
		CLASSIFICATION		
		UNRESTRICTED		

Table 2 - Test Matrix: Except IDC only Tests - Continued

		TEST GROUP							
		9	11	12	13	14	15	16	
<b>QUANTITY OF CONNECTORS</b>									
72476-1XY 4x6 WITH 0.8um GOLD PLATING			4			4		4	
72476-2XY 4x6 WITH 2.0UM GOLD PLATING									
72476-3XY 4x6 WITH 1.3um GOLD PLATING									
72476-9XY 4x6 WITH 0.8um GXT PLATING		4		4	4		4		
<b>QUANTITY OF HEADERS</b>									
70232-12Z 4x6 WITH 0.8um GOLD PLATING			4			4		4	
70232-51Z 4x6 WITH 1.3um GXT PLATING &					4				
70232-92Z 4x6 WITH 0.8um GXT PLATING		4		4			4		
<b>TEST</b>	<b>PARA</b>	<b>TEST SEQUENCE</b>							
EXAMINATION OF PRODUCT	3.1	1,3	1,3	1,3	1,3	1,3	1,3	1,3	
<b><u>ELECTRICAL CHARACTERISTICS</u></b>									
CONNECTOR CONTACT RESISTANCE	6.1	X	X	X	X	X	X	X	
CURRENT CARRYING CAPACITY	6.2								
INSULATION RESISTANCE <sup>2</sup>	6.3				X		X		
DIELECTRIC WITHSTANDING VOLTAGE <sup>2</sup>	6.4				X		X		
<b><u>MECHANICAL CHARACTERISTICS</u></b>									
MATING FORCE <sup>1</sup>	7.1								
UNMATING FORCE <sup>1</sup>	7.2				4				
CONTACT NORMAL FORCE	7.3								
IDC RETENTION ( AXIAL )	7.4								
IDC RETENTION ( 90° )	7.5								
COVER RETENTION	7.6								
LATCH RETENTION	7.7								
UNLATCHING MECHANISM	7.8								
<b><u>ENVIRONMENTAL CONDITIONS</u></b>									
BATTELLE MIXED GAS CLASS II + SO <sub>2</sub>	8.2.1	2	2						
INDUSTRIAL CORROSION Ke - CO	8.2.2			2		2			
INDUSTRIAL CORROSION Ke - UE	8.2.3				2				
THERM. SHOCK -CLIMATIC SEQUENCE	8.4						2	2	

	TYPE	PRODUCT SPECIFICATION	NUMBER	GS-12-015
	TITLE		PAGE	REVISION
72476, 72477, 74894, & 74896 Type Metral 4-Row Unshielded Cable Connectors		22 of 28		D
		AUTHORIZED BY	DATE	
		J. R. Volstorf	25-Apr-06	
		CLASSIFICATION		
		UNRESTRICTED		

Table 3 - Test Matrix: Except IDC only Tests - Continued

		TEST GROUP							
		17	18	19	20	21	22	23	24
<b>QUANTITY OF CONNECTORS</b>									
72476-1XY 4x6 WITH 0.8um GOLD PLATING				4		4		4	
72476-2XY 4x6 WITH 2.0UM GOLD PLATING									
72476-3XY 4x6 WITH 1.3um GOLD PLATING									
72476-9XY 4x6 WITH 0.8um GXT PLATING		4	4		4		4		4
<b>QUANTITY OF HEADERS</b>									
70232-12Z 4x6 WITH 0.8um GOLD PLATING				4		4		4	
70232-51Z 4x6 WITH 1.3um GXT PLATING &		4							4
70232-92Z 4x6 WITH 0.8um GXT PLATING			4		4		4		
<b>TEST</b>	<b>PARA</b>	<b>TEST SEQUENCE</b>							
EXAMINATION OF PRODUCT	3.1	1,3	1,3	1,3	1,3	1,3	1,3	1,3	1,3
<b>ELECTRICAL CHARACTERISTICS</b>									
CONNECTOR CONTACT RESISTANCE	6.1	X	X	X	X	X	X	X	X
CURRENT CARRYING CAPACITY	6.2								
INSULATION RESISTANCE <sup>2</sup>	6.3				X		X		X
DIELECTRIC WITHSTANDING VOLTAGE <sup>2</sup>	6.4				X		X		X
<b>MECHANICAL CHARACTERISTICS</b>									
MATING FORCE <sup>1</sup>	7.1				X	X	X	X	X
UNMATING FORCE <sup>1</sup>	7.2				X	X	X	X	X
CONTACT NORMAL FORCE	7.3								
IDC RETENTION ( AXIAL )	7.4								
IDC RETENTION ( 90° )	7.5								
COVER RETENTION	7.6								
LATCH RETENTION	7.7								
UNLATCHING MECHANISM	7.8								
<b>ENVIRONMENTAL CONDITIONS</b>									
VIBRATION	8.5	2							
VIBRATION-MECH. SHOCK - CO	8.6.1		2	2					
VIBRAT-MECH SHOCK - CO=BELLCORE	8.6.2				2	2			
THERM. SHOCK-MOIST. RESIST. - CO	8.7.1						2	2	
THERM. SHOCK-MOIST. RESIST. - UE	8.7.2								2

	TYPE	PRODUCT SPECIFICATION	NUMBER	GS-12-015
	TITLE		PAGE	REVISION
72476, 72477, 74894, & 74896 Type Metral 4-Row Unshielded Cable Connectors		23 of 28		D
		AUTHORIZED BY	DATE	
		J. R. Volstorf	25-Apr-06	
		CLASSIFICATION		
		UNRESTRICTED		

Table 4 - Test Matrix: Except IDC only Tests - Continued

		TEST GROUP							
		25	26	27	28	29	30	31	32
<b>QUANTITY OF CONNECTORS</b>									
72394-X11		4	4						
72394-X12				4	4				
72476-XYZ								10	10
72476-XY1						10			
72477-XY1							10		
<b>DESCRIPTION OF WIRE OR CABLE</b>									
30 GAGE WIRE PER P/N 301600-001					X				
28 GAGE WIRE PER COMCODE 406108720				X					
26 GAGE WIRE PER P/N 301595-001			X						
24 GAGE WIRE PER COMCODE 844514125		X							
807A CABLE 16/26 (LUCENT) OR						X			
808A CABLE 32/26 (LUCENT) OR							X		
<b>TEST</b>	<b>PARA</b>	<b>TEST SEQUENCE</b>							
EXAMINATION OF PRODUCT	3.1	1,3	1,3	1,3	1,3	1,6	1,6	1,3	1,4
<b>MECHANICAL CHARACTERISTICS</b>									
IDC RETENTION ( AXIAL )	7.4		2		2				
IDC RETENTION ( 90° )	7.5	2		2					
LATCH RETENTION	7.7							2	5
UNLATCH MECHANISM	7.8								3
CONNECTOR-CABLE ROBUSTNESS	7.9.1					2	2		
CONNECTOR-CABLE ROTATION	7.9.2					3	3		
CONNECTOR-CABLE PULL	7.9.3					4	4		
CONNECTOR-CABLE TORSION	7.9.4					5	5		
<b>ENVIRONMENTAL CONDITIONS</b>									
THERMAL AGE	8.1.4								2



	TYPE	PRODUCT SPECIFICATION	NUMBER	GS-12-015
	TITLE		PAGE	REVISION
72476, 72477, 74894, & 74896 Type Metral 4-Row Unshielded Cable Connectors		24 of 28		D
		AUTHORIZED BY	DATE	
		J. R. Volstorf	25-Apr-06	
		CLASSIFICATION		
		UNRESTRICTED		

Table 5 - Test Matrix: IDC only Tests

		TEST GROUP							
QUANTITY OF CONNECTORS		A	B	C	D	E	F	G	
72394-W11 2X5 CONN. SUB-ASSEM.		8	8	8					
72394-W12 2X5 CONN. SUB-ASSEM.					8	8	8	8	
72394-W11 2X5 WITH Ni PLATE ALL									
72394-W12 2X5 WITH Ni PLATE ALL									
<b>WIRE SPECIFICATION</b>									
UNINSULATED TINNED 30 GAGE					X				
UNINSULATED TINNED 28 GAGE						X			
UNINSULATED TINNED 26 GAGE		X							
30 GAGE PER P/N 301600-001							X		
28 GAGE PER P/N 406108720								X	
26 GAGE PER P/N 301595-001			X						
24 GAGE PER P/N 844514125				X					
<b>TEST</b>	<b>PARA</b>	<b>TEST SEQUENCE</b>							
EXAMINATION OF PRODUCT	3.1	1, 3	1, 3	1, 3	1, 3	1, 3	1, 3	1, 3	
<b>ENVIRONMENTAL CONDITIONS</b>									
THERMAL AGE <sup>1</sup> 100°C, 112 DAY	8.1.2	2	2	2	2	2	2	2	



	TYPE	PRODUCT SPECIFICATION		NUMBER	GS-12-015	
	TITLE			PAGE	REVISION	
72476, 72477, 74894, & 74896 Type Metral 4-Row Unshielded Cable Connectors			25 of 28		D	
			AUTHORIZED BY		DATE	
			J. R. Volstorf		25-Apr-06	
			CLASSIFICATION			
			UNRESTRICTED			

**9.4. Acceptance**

Electrical and mechanical requirements placed on test samples as indicated in the sections of this specification shall be established from test data using appropriate statistical techniques or shall otherwise be customer specified, and all samples tested in accordance with the product specification shall meet these requirements.

Failures attributed to equipment, test set-up or operator error shall not disqualify the product. If product failure occurs, corrective action shall be taken and samples resubmitted for qualification.

**9.5. Qualification Testing**

Qualification testing shall be performed on connectors and headers produced with equipment and procedures normally used in production.

**9.6. Regualification Testing**

If any of the following conditions occur, the responsible product engineer shall initiate requalification testing consisting of all applicable parts of the qualification test matrix, Table 1.

1. A significant design change is made to the existing product which impacts the product form, fit or function. Examples of significant changes shall include, but not be limited to, changes in the plating, material composition or thickness, contact force, pin/contact surface geometry, insulator or housing design, pin/contact base material or pin/contact lubrication.
2. A significant change is made to the manufacturing process which impacts the product form, fit or function.
3. A significant event occurs during production or end use requiring corrective action to be taken relative to the product design or manufacturing process

**NOTES**

The following table list the cad files imported into this document.

Figure	Autocad File
1	G12015_A
2	G12015_B
3	G12015_C
4	G12015_D
5	G12015_E
6	G12015_F

	TYPE	PRODUCT SPECIFICATION		NUMBER	GS-12-015	
	TITLE			PAGE	REVISION	
72476, 72477, 74894, & 74896 Type Metral 4-Row Unshielded Cable Connectors			26 of 28		D	
			AUTHORIZED BY		DATE	
			J. R. Volstorf		25-Apr-06	
			CLASSIFICATION			
			UNRESTRICTED			

11. **REFERENCE DOCUMENTS**

The following documents, of the issue in effect of the date of the latest revision of this specification, shall form a part of this specification to the extent specified herein.

11.1. **FCI Documents**

11.1.1. **Product Drawings**

Drawing Number	Description
70289	Latch Finger ( Standard )
72391	Contact, Blank & Plate
72392	Contact, Formed
72393	2x6 & 2X12 Insulators
72394	Connector Sub-Assemblies Standard
72388	Coding Keys
72389	Short Latch Finger
72395	6x4 Covers
72476	6x4 Cable Connector, Standard
72477	12x4 Cable Connector, Standard
72513	12x4 Covers
74893	2x6 Connector Sub-Assembly, Specials
74894	6x4 Cable Connector, Specials
74895	2x12 Connector Sub-Assembly, Specials
74896	12x4 Cable Connector, Specials

11.1.2. **Process Specifications**

Specification	Description
BUS-01-040	VG Site Equipment Calibration Guidelines
BUS-03-404	Normal Force Measurements
BUS-03-601	Current Rating/ 30° C Temperature Rise
BUS-15-002	Nickel Plating
GS-46-001	Tin ( Lead Free ) Plating
BUS-15-006	Tin/Lead Plating
BUS-15-005	Palladium Nickel Alloy Plating
BUS-15-008	Gold in Contact Plating
BUS-19-002	Solderability
BUS-19-020	Porosity, Plating
BUS-19-040	Adhesion, Plating
GES-20-002	Application, Cable Connector Assembly

	TYPE	PRODUCT SPECIFICATION		NUMBER	GS-12-015
	TITLE			PAGE	REVISION
72476, 72477, 74894, & 74896 Type Metral 4-Row Unshielded Cable Connectors			27 of 28	D	
			AUTHORIZED BY	DATE	
			J. R. Volstorf	25-Apr-06	
			CLASSIFICATION		
			UNRESTRICTED		

**11.2 Other Standards and Specifications**

UL94-V0: Tests for Flammability of Plastic Materials in Devices and Appliances

IEC 512: International Electrical Commission Standards

IEC 1076:

X-20954: Lucent Technologies Specification "Qualification Requirements for Separable and Non-Separable Electro-Mechanical Connections"

GR-1089-CORE: Bellcore Specification "Electromagnetic Compatibility and Electrical Safety - Generic Criteria for Network telecommunications Equipment"

GR-1217-CORE: Bellcore Specification "Generic Requirements for Separable Electrical Connectors"

EIA 364: Electrical Connector/Socket Test Procedures Including Environmental Classifications

**11.3. Lab Reports - Supporting Data**

- AT&T Internal Memorandum #536140000-940519-01IM, "X-20462 Thermal Age Qualification of 100 gram Normal Force - 2mm IDC Cable Connector"
- AT&T Internal Memorandum #536140000-940411-01IM, "X-20462 Vibration and Shock Qualification of 100 gram Normal Force - 2mm IDC Cable Connector"
- AT&T Internal Memorandum #536140000-940425-01IM, "X-20462 Temperature Cycling and Insertion Force Qualification of 100 gram Normal Force - 2mm IDC Cable Connector"
- AT&T Internal Memorandum #536140000-940512-01IM, "X-20462 Atmospheric Corrosion Qualification of 100 gram Normal Force - 2mm IDC Cable Connector"

**12. EQUIVALENT QUALIFICATION TESTING**

If the equivalent tests as specified for test groups 1 through 24 in this specification are conducted on cable connectors per product specification GES-12-16 or for test groups 9 through 24 per product specification GES-12-108, then that shall be considered as the same as having tested the product per this specification. If the equivalent tests as specified for test groups A through G in this specification are conducted on cable connectors per product specification GES-12-086, then that shall be considered as the same as having tested the product per this specification. In addition if other wire types are tested per specification GES-12-086 to the equivalent of section 8.1.2 of this specification, then that shall be considered as having qualified additional wire types per this specification.

	TYPE <b>PRODUCT SPECIFICATION</b>	NUMBER <b>GS-12-015</b>	
	TITLE 72476, 72477, 74894, & 74896 Type Metral 4-Row Unshielded Cable Connectors	PAGE 28 of 28	REVISION D
AUTHORIZED BY J. R. Volstorf		DATE 25-Apr-06	
CLASSIFICATION <b>UNRESTRICTED</b>			

**REVISION RECORD**

REV	PAGE	DESCRIPTION	EC #	DATE
A	ALL	NEW DOCUMENT	V94307	11/17/99
B	ALL	Revised format to be consistent with GS-01-001, and change BERG, Dupont, etc. references to FCI. Change document number prefix from GES to GS.	V01949	08/15/00
C	ALL	Add lead free information	V05-0940	10/05/05
D	ALL	Change to new logo	V06-0404	4/25/06