	<b>TYPE</b> <b>PRODUCT SPECIFICATION</b>	<b>NUMBER</b> <b>GS-12-016</b> <b>(Was GES-12-016)</b>	
	<b>TITLE</b> 72478, 72479, 74898, 74899, 84666, & Type Metral 5-Row Unshielded Cable Connectors	<b>PAGE</b> 1 of 30	<b>REVISION</b> D
		<b>AUTHORIZED BY</b> J. R. Volstorf	<b>DATE</b> 25-Apr-06
		<b>STATUS</b> <b>UNRESTRICTED</b>	

**CONTENTS**

1. Purpose ..... 4

2. Scope ..... 4

3. GENERAL ..... 4

    3.1. Design and Construction ..... 4

    3.2. Workmanship ..... 4

    3.3. Usage ..... 4

    3.4. Visual ..... 4

4. Product Descriptions ..... 5

    4.1. 72478 type 5-row Metral™ Unshielded Connector ..... 5

    4.2. 72479 type 5-row Metral™ Unshielded Connector ..... 6

    4.3. 74898 type 5-row Metral™ Unshielded Connector ..... 6

    4.4. 74899 type 5-row Metral™ Unshielded Connector ..... 7

    4.5. 84666 type 5-row Metral™ Unshielded Connector ..... 7

    4.6. 84667 type 5-row Metral™ Unshielded Connector ..... 8

5. Requirements ..... 8

    5.1. Qualification ..... 8

    5.2. Material ..... 8

        5.2.1. Metallic Parts ..... 8

        5.2.2. Plastic Parts ..... 8

    5.3. Finish ..... 9

        5.3.1. Metallic Parts ..... 9

        5.3.2. Plastic Parts ..... 9

6. Electrical Characteristics ..... 9

    6.1. Connector Contact Resistance ..... 9

    6.2. Current Carrying Capacity ..... 9

    6.3. Insulation Resistance ..... 9

    6.4. Dielectric Withstanding Voltage ..... 9

7. MECHANICAL CHARACTERISTICS ..... 10

    7.1. Mating Force ..... 10

    7.2. Unmating Force ..... 10

    7.3. Contact Normal Force on Pin ..... 10

    7.4. Connector IDC Termination Retention ( Axial ) ..... 10

    7.5. Connector IDC Termination Retention ( 90° ) ..... 10

    7.6. Cover Retention on Connector ..... 11

    7.7. Latch Retention ..... 11

	<b>TYPE</b> <b>PRODUCT SPECIFICATION</b>	<b>NUMBER</b> <b>GS-12-016</b> <b>(Was GES-12-016)</b>	
	<b>TITLE</b> 72478, 72479, 74898, 74899, 84666, & Type Metral 5-Row Unshielded Cable Connectors	<b>PAGE</b> 2 of 30	<b>REVISION</b> D
		<b>AUTHORIZED BY</b> J. R. Volstorf	<b>DATE</b> 25-Apr-06
		<b>STATUS</b> <b>UNRESTRICTED</b>	

7.8. Unlatching Mechanism .....	11
7.9. Cable Clamp Tests .....	12
7.9.1. Robustness .....	12
7.9.2. Resistance to Cable Rotation .....	12
7.9.3. Resistance to Cable Pull.....	12
7.9.4. Resistance to Cable Torsion .....	12
7.10. Insulator Retention in Covers .....	12
<b>8. Environmental conditions .....</b>	<b>13</b>
8.1. Thermal Age .....	13
8.1.1. For Test Groups 1 - 3 .....	13
8.1.2. For Test Groups A, B, C, D, E, F, & G.....	14
8.1.3. For Test Groups 4-5 .....	14
8.1.4. For Test Groups 33, 34 & 38 .....	14
8.2.Mixed Flowing Gas .....	15
8.2.1. Battelle II + SO <sub>2</sub> - Central Office .....	15
8.2.2. Industrial Corrosion Ke Test - Central Office.....	16
8.2.3. Industrial Corrosion Ke Test - Uncontrolled Environment .....	16
8.3. High Humidity Endurance .....	17
8.4. Thermal Shock - Climatic Sequence .....	17
8.5. Vibration .....	18
8.6. Vibration - Mechanical Shock .....	18
8.6.1. Central Office Environment - IEC .....	18
8.6.2. Central Office Environment - Bellcore .....	19
8.7.Thermal Shock - Moisture Resistance.....	19
8.7.1. Central Office Environment - Bellcore .....	19
8.7.2. Uncontrolled Environment - Bellcore .....	20
<b>9. Quality assurance provisions .....</b>	<b>20</b>
9.1. Equipment Calibration .....	20
9.2. Inspection Conditions .....	20
9.3. Sample Quantity and Description .....	20
9.4. Acceptance .....	26
9.5. Qualification Testing .....	26
9.6. Requalification Testing .....	27
<b>10. NOTES.....</b>	<b>27</b>
<b>11. REFERENCE DOCUMENTS .....</b>	<b>27</b>
11.1.1. Product Drawings .....	28
11.1.2. Process Specifications.....	28
11.2. Other Standards and Specifications .....	29
11.3. Lab Reports - Supporting Data .....	29
<b>12. EQUIVALENT QUALIFCATION TESTING.....</b>	<b>29</b>



	<b>TYPE</b> <b>PRODUCT SPECIFICATION</b>	<b>NUMBER</b> <b>GS-12-016</b> <b>(Was GES-12-016)</b>	
<b>TITLE</b> 72478, 72479, 74898, 74899, 84666, & Type Metral 5-Row Unshielded Cable Connectors		<b>PAGE</b> 3 of 30	<b>REVISION</b> D
		<b>AUTHORIZED BY</b> J. R. Volstorf	<b>DATE</b> 25-Apr-06
		<b>STATUS</b> <b>UNRESTRICTED</b>	

Figure 1 5x6 Unshielded Connector .....5  
Figure 2 5x12 Unshielded Connector .....6  
Figure 3 5x4 Unshielded Connector .....7  
Figure 4 5x4 Unshielded Connector .....8  
Figure 5 Axial Contact Retention .....10  
Figure 6 90 Deg. Contact Retention .....11  
Figure 7 Cover Retention.....11  
Figure 8 Insulator Retention In Covers.....12

Table 1 - Test Matrix: Except IDC only Tests .....21  
Table 2 - Test Matrix: Except IDC only Tests - Continued .....22  
Table 3 - Test Matrix: Except IDC only Tests - Continued .....23  
Table 4 - Test Matrix: Except IDC only Tests - Continued .....24  
Table 5 - Test Matrix: Except IDC only Tests - Continued .....25  
Table 6 - Test Matrix: IDC only Tests .....26

	TYPE <b>PRODUCT SPECIFICATION</b>	NUMBER <b>GS-12-016</b> (Was GES-12-016)	
TITLE 72478, 72479, 74898, 74899, 84666, & Type Metral 5-Row Unshielded Cable Connectors		PAGE 4 of 30	REVISION D
		AUTHORIZED BY J. R. Volstorf	DATE 25-Apr-06
		STATUS <b>UNRESTRICTED</b>	

## 1.0 PURPOSE

This specification defines the performance, test, quality, and reliability requirements for the 72478-X0Y and 74898-NNN 5x6, the 72479-X0Y and 74899-NNN 5x12, the 84666-NNN 5x4 and the 84667-NNN 5x16 Unshielded Cable Connectors.

## 2.0 SCOPE

This specification is applicable to qualification testing of the 72478, 72479, 74898 and 74899 type Cable Connectors used in conjunction with standard 5-Row Metral™ Unshielded Headers and the 84666 and 84667 type Cable Connectors used in conjunction with special 84669 type 5-Row Metral™ Unshielded Headers.

## 3.0 GENERAL

### 3.1 Design and Construction

Connectors, Covers and Headers shall be of the design, construction and physical dimensions specified on the applicable product drawings. The cable connector and header shall be capable of mating without any degradation in performance.

### 3.2 Workmanship

Workmanship shall be of a level that indicates controlled conditions of manufacture such that subsequent operations, functionality and performance are not degraded.

### 3.3 Usage

The connectors and headers covered by this instruction are intended for use in a wide variety of environments and are designed to meet the conditions specified in Bellcore GR-1217-CORE.

#### **Banned/Restricted Substances**

All product where the part number ends in 'LF' meet the European Union directives and other country regulations as described in GS-22-008. The part numbers that do not end in 'LF' meet all regulations except for Pb in SnPb plating.

#### **Manufacturing Processability**

All products covered by this specification will not withstand exposure to convection, infra-red or vapor phase reflow ovens. Do not heat this product above 110°C.

### 3.4 Visual

Visual examinations shall be performed with a magnification of up to 10x. (8 to 10x recommended).

	<b>TYPE</b> <b>PRODUCT SPECIFICATION</b>	<b>NUMBER</b> <b>GS-12-016</b> <b>(Was GES-12-016)</b>	
	<b>TITLE</b> 72478, 72479, 74898, 74899, 84666, & Type Metral 5-Row Unshielded Cable Connectors	<b>PAGE</b> 5 of 30	<b>REVISION</b> D
	<b>AUTHORIZED BY</b> J. R. Volstorf	<b>DATE</b> 25-Apr-06	
	<b>STATUS</b> <b>UNRESTRICTED</b>		

#### 4.0 PRODUCT DESCRIPTIONS

##### 4.1 72478 Type 5-Row Metral™ Unshielded Connector

This connector is a 5x6 2mm pitch cable connector with IDC type contacts. The connectors have the following variations.

as 72478-wxy1 where

“w” specifies the plating on the separable contact

w = 1 , for 0.8um Gold

w = 2 , for 2.0um Gold

w = 3 , for 1.3um Gold

w = 9 , for 0.8um GXT

“y” specifies the wire gage capacity

y = 1 , for 26-24 gage wire

y = 2 , for 30-28 gage wire

“x” specifies the latch finger type

x = 1 , for cable diameters up to 7.0mm

x = 2 , for cable diameters up to 11.0mm

**Figure 1 5x6 Unshielded Connector**

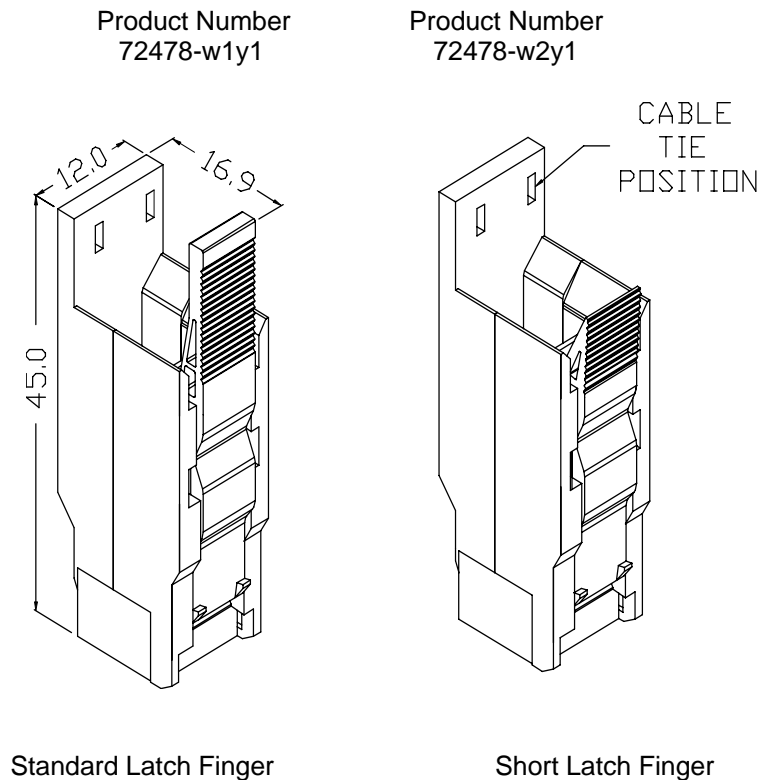

The difference between the standard latch finger ( x = 1 ) and the short latch finger ( x = 2 ) is that the standard latch stands above the cable tie and is easier to access but thus restricts the maximum diameter cable that can be used. In certain cases the use of multiple cables or the stripping of the cable jacket above the cable tie area of the connector will allow the user to overcome some restrictions.

	<b>TYPE</b> <b>PRODUCT SPECIFICATION</b>	<b>NUMBER</b> <b>GS-12-016</b> <b>(Was GES-12-016)</b>	
	<b>TITLE</b> 72478, 72479, 74898, 74899, 84666, & Type Metral 5-Row Unshielded Cable Connectors	<b>PAGE</b> 6 of 30	<b>REVISION</b> D
		<b>AUTHORIZED BY</b> J. R. Volstorf	<b>DATE</b> 25-Apr-06
		<b>STATUS</b> <b>UNRESTRICTED</b>	

**4.2 72479 Type 5-Row Metral™ Unshielded Connector**

This connector is a 5x12 2mm pitch cable connector with IDC type contacts. The connectors have the same variations as the 72478 types and adapt to slightly larger cables.

as 72479-wxy1 where

x = 1 , for cable diameters up to 9.5mm

x = 2 , for cable diameters up to 11.5mm

**Figure 2 5x12 Unshielded Connector**

Product Number

72479-w1y1

Product Number

72479-w2y1

Standard Latch Finger

Short Latch Finger

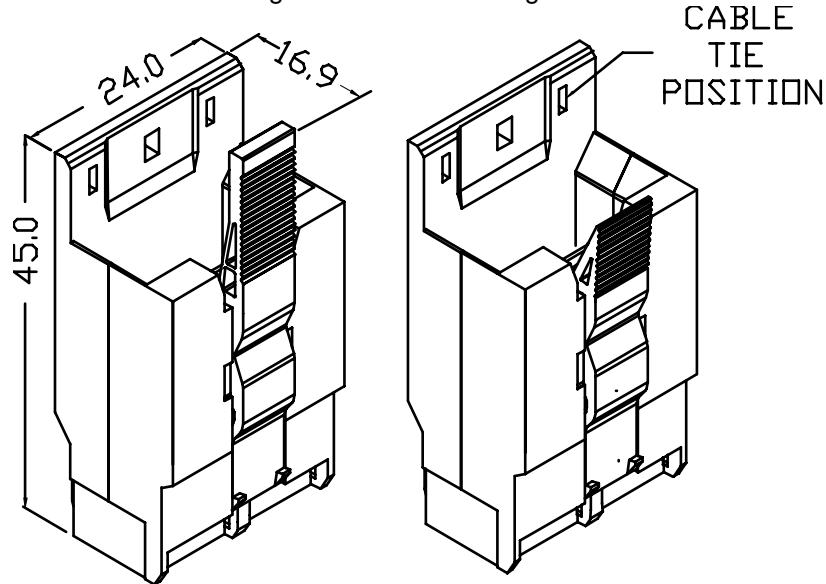

**4.3 74898 Type 5 Row Metral™ Unshielded Connector**

This connector is a 5x6 2mm pitch cable connector with IDC type contacts. The connectors are basically the same as the 72478 types but have special variations. These variations may include selective loaded contacts, dimensional or color variations of the standard molded parts, special plating on the contacts, addition parts and/or special markings. Due to the possible complexity of the variations there is no numbering scheme to define the variations. The differences compared to the standard product can only be determined by examining the product drawings.

	TYPE <b>PRODUCT SPECIFICATION</b>	NUMBER <b>GS-12-016</b> (Was GES-12-016)	
TITLE 72478, 72479, 74898, 74899, 84666, & Type Metral 5-Row Unshielded Cable Connectors		PAGE 7 of 30	REVISION D
		AUTHORIZED BY J. R. Volstorf	DATE 25-Apr-06
		STATUS <b>UNRESTRICTED</b>	

#### 4.4 74899 Type 5-Row Metral™ Unshielded Connector

This connector is a 5x12 2mm pitch cable connector with IDC type contacts. The connectors are basically the same as the 72479 types but have special variations. These variations may include selective loaded contacts, dimensional or color variations of the standard molded parts, special plating on the contacts, addition parts and/or special markings. Due to the possible complexity of the variations there is no numbering scheme to define the variations. The differences compared to the standard product can only be determined by examining the product drawings.

#### 4.5 84666 Type 5-Row Metral™ Unshielded Connector

This connector is a 5x4 2mm pitch cable connector with IDC type contacts. The connectors have special variations. These variations may include selective loaded contacts, dimensional or color variations of the standard molded parts, special plating on the contacts, addition parts and/or special markings. Due to the possible complexity of the variations there is no numbering scheme to define the variations. The differences compared to the standard product can only be determined by examining the product drawings.

**Figure 3 5x4 Unshielded Connector**

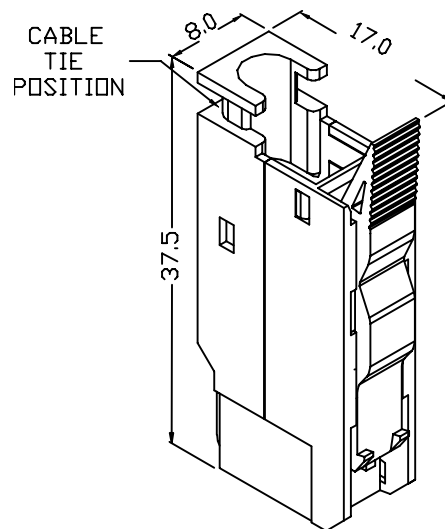

	<b>TYPE</b> <b>PRODUCT SPECIFICATION</b>	<b>NUMBER</b> <b>GS-12-016</b> <b>(Was GES-12-016)</b>	
	<b>TITLE</b> 72478, 72479, 74898, 74899, 84666, & Type Metral 5-Row Unshielded Cable Connectors	<b>PAGE</b> 8 of 30	<b>REVISION</b> D
		<b>AUTHORIZED BY</b> J. R. Volstorf	<b>DATE</b> 25-Apr-06
		<b>STATUS</b> <b>UNRESTRICTED</b>	

#### 4.6 **84667 Type 5-row Metral™ Unshielded Connector**

This connector is a 5x16 2mm pitch cable connector with IDC type contacts. The connectors have special variations. These variations may include selective loaded contacts, dimensional or color variations of the standard molded parts, special plating on the contacts, addition parts and/or special markings. Due to the possible complexity of the variations there is no numbering scheme to define the variations. The differences compared to the standard product can only be determined by examining the product drawings.

**Figure 4 5x4 Unshielded Connector**

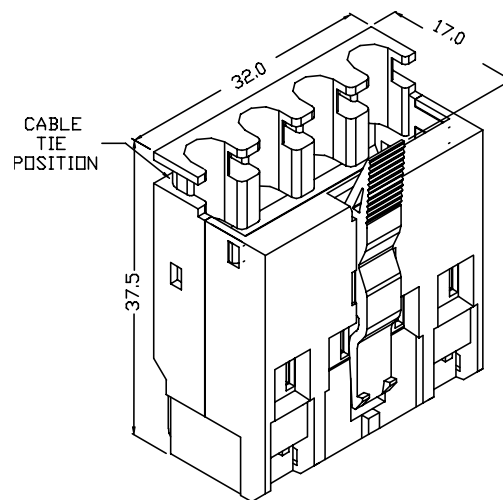

## 5.0 **REQUIREMENTS**

### 5.1 **Qualification**

Connectors furnished under this specification shall be capable of meeting the qualification test requirements specified herein.

### 5.2 **Material**

#### 5.2.1 **Metallic Parts**

Contact, Connector: Phosphor Bronze Strip, C52100, 0.0080 ±0.0002 inch thick, UTS of 69,000 to 84,000 psi

#### 5.2.2 **Plastic Parts**

Insulator: 612 Polyamide, 30% GFR, Flame retardant UL94V-0, Natural  
Covers: 612 Polyamide, 30% GFR, Flame retardant UL94V-0, Natural  
Keys: 612 Polyamide, 30% GFR, Flame retardant UL94V-0, Natural  
Latch Fingers: Ultem 1010, Flame retardant UL94V-0, Black



	<b>TYPE</b> <b>PRODUCT SPECIFICATION</b>	<b>NUMBER</b> <b>GS-12-016</b> <b>(Was GES-12-016)</b>	
	<b>TITLE</b> 72478, 72479, 74898, 74899, 84666, & Type Metral 5-Row Unshielded Cable Connectors	<b>PAGE</b> 9 of 30	<b>REVISION</b> D
		<b>AUTHORIZED BY</b> J. R. Volstorf	<b>DATE</b> 25-Apr-06
		<b>STATUS</b> <b>UNRESTRICTED</b>	

### 5.3 Finish

#### 5.3.1 Metallic Parts

Contact, Connector:

IDC Dimples:

If part number does not end in 'LF'

93-7 (Sn-Pb) Solder, 1.3 micron min., 5.1 micron max.

If part number does end in 'LF'

Sn ( lead free ) Solder, 1.3 micron min., 5.1 micron max.

Separable Contacts:

- (a) 0.8 micron GXT/1.3 micron nickel
- (b) 0.8 micron Gold/1.3 micron nickel
- (c) 1.3 micron Gold/1.3 micron nickel
- (d) 2.0 micron Gold/1.3 micron nickel

#### 5.3.2 Plastic Parts

No finish on plastic parts

### 6.0 ELECTRICAL CHARACTERISTICS

#### 6.1 Connector Contact Resistance

The bulk resistance of the contact shall be measured in accordance with EIA-364-23 at the following conditions.

Test voltage - 20 millivolts DC maximum open circuit

Test current - Not to exceed 100 milliamperes

#### 6.2 Current Carrying Capacity

The current carrying capacity of a mated signal pair is rated at 1 ampere with current applied to all contacts when measured in accordance with EIA-364-70. Temperature rise should not exceed 30° C.

#### 6.3 Insulation Resistance

The insulation resistance of unmated connectors and headers shall be no less than 5000 megohms initially and no less than 1000 megohms after environmental exposure when measure in accordance with EIA-364-21 at the following conditions.

Test voltage: 200 VDC

Electrification time: 2 minutes

Points of measurement: Between adjacent contacts and pins.

#### 6.4 Dielectric Withstanding Voltage

There shall be no evidence of arc-over, insulation breakdown or excessive leakage current (>1 milliamperes) when unmated connectors and headers are tested in accordance with EIA-364-20 at the following conditions.

Test voltage: 1000 VDC or 1000 VAC peak-to-peak

Test Duration: 60 seconds

Test condition: 1 atm

Points of measurement: Between adjacent contacts and pins

	TYPE <b>PRODUCT SPECIFICATION</b>	NUMBER <b>GS-12-016</b> (Was GES-12-016)	
	TITLE 72478, 72479, 74898, 74899, 84666, & Type Metral 5-Row Unshielded Cable Connectors	PAGE 10 of 30	REVISION D
		AUTHORIZED BY J. R. Volstorf	DATE 25-Apr-06
		STATUS <b>UNRESTRICTED</b>	

## 7.0 MECHANICAL CHARACTERISTICS

### 7.1 Mating Force

The total force to mate the connector to the header shall not exceed 1.0 Newton times the number of contacts, when measured in accordance with EIA-364-13

### 7.2 Unmating Force

The total force to withdraw the connector from the header shall not exceed 1.13 Newton times the number of contacts, when measured in accordance with EIA-364-13. The minimum force shall exceed 0.2 Newton times the number of contacts, when measures in accordance with EIA-364-13.

### 7.3 Contact Normal Force on Pin

The contact normal force on the pin shall be no less than 50 grams, when measured in accordance with EIA-364-04

### 7.4 Connector IDC Termination Retention ( Axial )

There shall be no loosening of the IDC termination or the contact in the insulator or damage to the IDC termination, contact or connector when a 13.4 Newton axial force is applied to a wire, in accordance with GS-20-003. inimum sample size is 10 contacts per specimen.

**Figure 5 Axial Contact Retention**

There shall be no loosening of the IDC termination or the contact in the insulator or damage to the

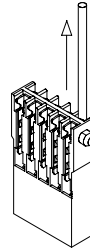

### Connector IDC Termination Retention ( 90° )

There shall be no loosening of the IDC termination or the contact in the insulator or damage to the IDC termination, contact or connector when a 8.9 Newton force is applied at a 90° angle to a wire, in accordance with GS-20-003. inimum samples size is 10 contacts per specimen.

	<b>TYPE</b> <b>PRODUCT SPECIFICATION</b>	<b>NUMBER</b> <b>GS-12-016</b> <b>(Was GES-12-016)</b>	
	<b>TITLE</b> 72478, 72479, 74898, 74899, 84666, & Type Metral 5-Row Unshielded Cable Connectors	<b>PAGE</b> 11 of 30	<b>REVISION</b> D
		<b>AUTHORIZED BY</b> J. R. Volstorf	<b>DATE</b> 25-Apr-06
		<b>STATUS</b> <b>UNRESTRICTED</b>	

**Figure 6 90 Deg. Contact Retention**

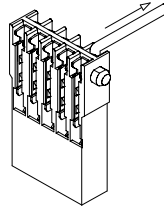

**7.6 Retention on Connector**

When the covers are assembled to the connector sub-assemblies, the assembly shall withstand the specified load. The press fit plastic studs of the latch side cover shall not be broken or cracked and the plastic of the covers shall not be broken or cracked nor shall the two parts unmate. The minimum retention force is 20 Newtons for 72478, 74898, 84666 and 84667 type connectors and 30 Newtons for the 72479 and 74899 type connectors.

**Figure 7 Cover Retention**

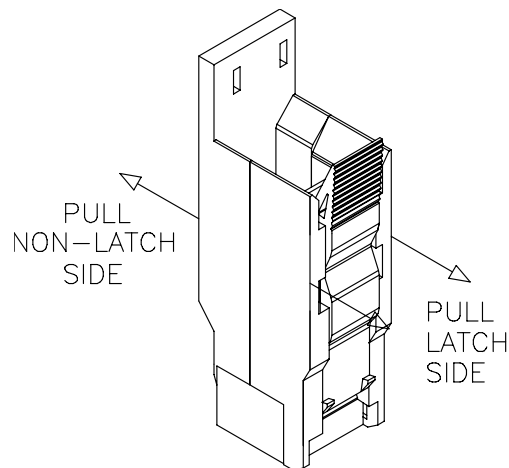

**7.7 Latch Retention**

When the 72478, 72479, 74898 and 74899 type connectors are mated with standard Metral™ 5-row unshielded headers or the 84666 and 84667 type connectors are mated with the 84669 Metral™ 5-row unshielded headers, the cover and cable connector assembly shall withstand a 44.5N (10 pound) axial pull force applied against the cover latching details.

**7.8 Unlatching Mechanism**

The latch finger used to retain the cable assembly in the header shall withstand 200 insertion and extraction cycles without cracking or breaking.

	TYPE <b>PRODUCT SPECIFICATION</b>	NUMBER <b>GS-12-016</b> (Was GES-12-016)	
	TITLE 72478, 72479, 74898, 74899, 84666, & Type Metral 5-Row Unshielded Cable Connectors	PAGE 12 of 30	REVISION D
		AUTHORIZED BY J. R. Volstorf	DATE 25-Apr-06
		STATUS <b>UNRESTRICTED</b>	

## 7.9 Cable Clamp Tests

Minimum sample size is 10 one ended cable assemblies. For 72478, 72479, 74898 and 74899 type connectors, prepare samples per GS-20-003. For 84666 and 84667 type connectors, prepare samples per GS-20-007.

### 7.9.1 Robustness

Test per IEC 512-9, test 17a. The length of the cable from the cable strain relief to the free end of the cable shall be  $20 \pm 4$  cm. Clamp specimens to base of Instron or equivalent pull test machine. Apply force equal to 2.23N ( 1/2 lb.) per contact at a distance of 10 cm from cable strain relief during test. Perform the test cycle once. Visually inspect parts after testing per IEC 512-2, Test 1a.

### 7.9.2 Resistance to Cable Rotation

Test per IEC 512-9, test 17b. Clamp specimens in vise in vertical position. Secure cable at  $15 \pm 3$  cm from cable strain relief for rotation. Perform two rotations at  $5 \pm 2$  second cycles. Visually inspect parts after testing per IEC 512-2, Test 1a.

### 7.9.3 Resistance to Cable Pull

Test per IEC 512-9, test 17c. Clamp specimens to base of Instron or equivalent pull test machine. Apply force equal to 2.23 N ( 1/2 lb.) per contact at a distance of 10 cm from cable strain relief during test. Perform the test cycle once. Visually inspect parts after testing per IEC 512-2, Test 1a. The cable jacket shall not be pulled out of the cable tie.

### 7.9.4 Resistance to Cable Torsion

Test per IEC 512-9, test 17d. Clamp specimens to base of test machine. Apply torque required to rotate the cable 360 degrees at a distance of 10 cm from cable strain relief during test. Perform the test cycle once. Visually inspect parts after testing per IEC 512-2, Test 1a. The cable jacket shall not be pulled out of the cable tie.

## 7.10 Insulator Retention in Covers

The insulators shall be retained in the covers such that they withstand a 5 Newton per contact force between the covers and insulators.

**Figure 8 Insulator Retention In Covers**

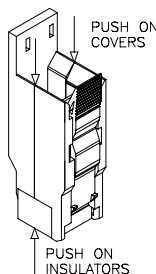

	TYPE <b>PRODUCT SPECIFICATION</b>	NUMBER <b>GS-12-016</b> (Was GES-12-016)	
TITLE 72478, 72479, 74898, 74899, 84666, & Type Metral 5-Row Unshielded Cable Connectors		PAGE 13 of 30	REVISION D
		AUTHORIZED BY J. R. Volstorf	DATE 25-Apr-06
		STATUS <b>UNRESTRICTED</b>	

## 8.0 ENVIRONMENTAL CONDITIONS

After exposure to the following environmental conditions in accordance with the specified test procedure and/or details, the product shall show no physical damage and shall meet the electrical and mechanical requirements in sections 6. And 7. as specified in “**Table 1 - Test Sequences**”. Unless specified otherwise, product shall be mated during exposure.

### 8.1 Thermal Age

#### 8.1.1 For Test Groups 1 - 3

Mated connectors and headers must meet the requirement of Bellcore GR-1217-CORE and Lucent Technologies Specification X-20954 section 4.06a when tested per IEC 68-2-2, test Bd. A minimum of 100 contacts for product exposed mated and 50 contacts for product exposed unmated shall be measured for contact resistance in this test. Contact resistance shall not change by more than 5 milliohms. A minimum of 10 contacts of group 1 shall be measured for insulation resistance and dielectric withstanding voltage.

#### Test Plan:

1. Divide test groups into two sub-groups. The second sub-group shall consist of 2 samples and the first sub-group the remaining. One of the samples of the first sub-group of group 1 shall be reserved for the insulation resistance and dielectric withstanding voltage tests.
2. Mate all samples and measure mating force.
3. Measure contact resistance of both groups
4. Measure insulation resistance and dielectric withstanding voltage of group 1, sub-group 1
5. Unmate and mate the second group for a total of 100 wear cycles. Measure unmating force on first unmate.
6. Measure contact resistance of the second group
7. Unmate the second group
8. Expose both groups to 105° C for the first 42 days and 100° C thereafter for a total of 112 days.
9. Interrupt the exposure at 21, 42 and 75 days allowing 2 hours for the groups to recover to ambient. Mate the second group and measure contact resistance. Unmate the second group before continuing exposure.
10. After 112 days, remove both groups and allow 24 to 72 hours to recover to ambient. Mate the second group and measure contact resistance of both groups.
11. Measure insulation resistance and dielectric withstanding voltage of group 1, sub-group 1
12. Add one unmate and mate cycle to both groups and measure contact resistance. Measure unmating and mating forces.

	<b>TYPE</b> <b>PRODUCT SPECIFICATION</b>	<b>NUMBER</b> <b>GS-12-016</b> <b>(Was GES-12-016)</b>	
	<b>TITLE</b> 72478, 72479, 74898, 74899, 84666, & Type Metral 5-Row Unshielded Cable Connectors	<b>PAGE</b> 14 of 30	<b>REVISION</b> D
		<b>AUTHORIZED BY</b> J. R. Volstorf	<b>DATE</b> 25-Apr-06
		<b>STATUS</b> <b>UNRESTRICTED</b>	

### 8.1.2 For Test Groups A, B, C, D, E, F, & G

The unmated connectors must meet the requirement of IEC 1076-4 and Lucent Technologies Specification X-20954 section 4.06a for the IDC only interface when tested per IEC 68-2-2, test Bd. The conditions of these tests shall be considered meet if contacts with the same IDC dimples ( 72384-X0Y) pass the same tests per product specification GS-12-108. Sample size is 80 minimum for all groups. Contact resistance shall not change by more than 1 milliohm.

#### Test Plan:

1. Measure contact resistance
2. Expose to 105° C for the first 42 days and 100° C thereafter for a total of 112 days.
3. Interrupt the exposure at 21, 42 and 75 days allowing 2 hours for recovery to ambient. Measure contact resistance.
4. After 112 days, remove product and allow 24 to 72 hours to recover to ambient, measure contact resistance

### 8.1.3 For Test Groups 4-5

Mated connectors and headers must meet the requirement of IEC 1076-4-110 ( Feb. 97 draft) and IEC 512-9b. A minimum of 30 contacts shall be measured for contact resistance in this test. Contact resistance shall not change by more than 5 milliohm. A minimum of 10 contacts of group 4 shall be measured for insulation resistance and dielectric withstanding voltage.

#### Test Plan:

1. Mate all samples
2. Measure contact resistance
3. Unmate and mate samples for a total of 100 wear cycles.
4. Measure contact resistance
5. Measure insulation resistance and dielectric withstanding voltage on sample of group 4.
6. Expose samples to 70° C under a 1 Amp load for 42 days
7. After 1000 hours, remove the samples and allow 1 hour min., 2 hours max. to recover to ambient. Measure contact resistance Measure insulation resistance and dielectric withstanding voltage on sample of group 4

### 8.1.4 For Test Groups 33, 34 & 38

This is a specification for the thermal age of the plastic parts only

#### Test Plan:

1. Expose to 100°C ±5°C for 24 ±4 hours.
2. After exposure remove product and allow 24 to 72 hours to recover to ambient.

	TYPE <b>PRODUCT SPECIFICATION</b>	NUMBER <b>GS-12-016</b> (Was GES-12-016)	
TITLE 72478, 72479, 74898, 74899, 84666, & Type Metral 5-Row Unshielded Cable Connectors		PAGE 15 of 30	REVISION D
		AUTHORIZED BY J. R. Volstorf	DATE 25-Apr-06
		STATUS <b>UNRESTRICTED</b>	

## 2 Mixed Flowing Gas

### 8.2.1 Battelle II + SO<sub>2</sub> - Central Office

Mated connectors and headers must meet the requirements of Bellcore Gr-1217-CORE Section 9.1.3 for Battelle II + SO<sub>2</sub>. A minimum of 100 contacts shall be measured in this test. Contact resistance shall not change by more than 5 milliohms.

#### Test Plan:

1. Mate all samples
2. Measure contact resistance
3. Unmate and mate 99 times for a total of 100 wear cycles
4. Measure contact resistance
5. Expose connectors to MFG environment for a total of 20 days in the following sequence.
  - Expose unmated connectors and headers for 5 days
  - Remove from chamber, mate and measure contact resistance
  - Disconnect and expose for 5 more days
  - Remove from chamber, mate and measure contact resistance
  - Expose mated connectors and headers for 5 more days
  - Remove from chamber, unmate, mate and measure contact resistance.
  - Expose mated connectors and headers for 5 more days
  - Remove from chamber and measure contact resistance
6. Disturb the connection ( approximately 0.004 inches) and measure contact resistance.
7. Unmate and mate 97 times for a total of 200 wear cycles
8. Measure contact resistance.
9. Visually inspect connectors for excessive degradation.

	<b>TYPE</b> <b>PRODUCT SPECIFICATION</b>	<b>NUMBER</b> <b>GS-12-016</b> <b>(Was GES-12-016)</b>	
	<b>TITLE</b> 72478, 72479, 74898, 74899, 84666, & Type Metral 5-Row Unshielded Cable Connectors	<b>PAGE</b> 16 of 30	<b>REVISION</b> D
		<b>AUTHORIZED BY</b> J. R. Volstorf	<b>DATE</b> 25-Apr-06
		<b>STATUS</b> <b>UNRESTRICTED</b>	

### 8.2.2 Industrial Corrosion Ke Test - Central Office

Mated connectors and headers must meet the requirements of IEC 68-2-60, test Ke (Method 1) and X-20954, Issue 2, Section 4.6.3.2. A minimum of 100 contacts shall be measured in this test. Contact resistance shall not change by more than 5 milliohms.

Test Plan:

1. Divide samples into two groups
2. Insert and measure contact resistance
3. Unmate and mate both groups 99 times for a total of 100 wear cycles
4. Measure contact resistance of both groups
5. Disconnect second group
6. Expose both groups to MFG environment for a total of 10 days.
7. Mate the second group and measure contact resistance of both groups.
8. Visually inspect connectors for excessive degradation.

### 8.2.3 Industrial Corrosion Ke Test - Uncontrolled Environment

Mated connectors and headers must meet the requirements of IEC 68-2-60, test Ke (Method 1) and X-20954, Issue 2, Section 4.6.3.2. A minimum of 100 contacts shall be measured in this test. Contact resistance shall not change by more than 5 milliohms. A minimum of 10 contacts shall be measured for insulation resistance and dielectric withstanding voltage.

Test Plan:

1. Divide samples into two sub-groups.
2. Insert and measure contact resistance. Measure insulation resistance and dielectric withstanding voltage on group 13.
3. Unmate and mate 99 times for a total of 100 wear cycles
4. Measure contact resistance.
5. Unmate second sub-group.
6. Expose all groups to MFG environment for a total of 21 days.
7. Remove from chamber and mate second sub-groups
8. Measure contact resistance of both sub-groups.
9. Measure insulation resistance and dielectric withstanding voltage on first sub-group of group 13.
10. Visually inspect connectors for excessive degradation.



	<b>TYPE</b> <b>PRODUCT SPECIFICATION</b>	<b>NUMBER</b> <b>GS-12-016</b> <b>(Was GES-12-016)</b>	
	<b>TITLE</b> 72478, 72479, 74898, 74899, 84666, & Type Metral 5-Row Unshielded Cable Connectors	<b>PAGE</b> 17 of 30	<b>REVISION</b> D
		<b>AUTHORIZED BY</b> J. R. Volstorf	<b>DATE</b> 25-Apr-06
		<b>STATUS</b> <b>UNRESTRICTED</b>	

### 8.3 High Humidity Endurance

Mated header and connector must meet the requirements of IEC 1076-4 when tested in accordance with IEC 68-2-3, test Ca. A minimum of 100 contacts shall be measured in this test for contact resistance. Contact resistance shall not change more than 5 milliohms in this test. A minimum of 10 contacts of group 6 shall be measured for insulation resistance and dielectric withstanding voltage.

#### Test Plan:

1. Measure mating and unmating forces.
2. All samples to be mated
3. Measure contact resistance.
4. Measure insulation resistance and dielectric withstanding voltage on group 6.
5. Expose all samples to 40° C/ 93%RH ( steady state ) for a total of 56 days at 60 VDC polarizing voltage.
6. Remove after 56 days
7. Between 1 and 2 hours after removal measure insulation resistance on group 6.
8. After 24 to 72 hours to recover to ambient, measure contact resistance. Measure dielectric withstanding voltage on group 6.
9. Measure mating and unmating forces.

### 8.4 Thermal Shock - Climatic Sequence

Mated headers and connectors must meet the requirements of IEC 68-2-14, test NA. A minimum of 100 contacts shall be measured in this test for contact resistance. Contact resistance shall not change by more than 5 milliohms. A minimum of 10 contacts of 'GXT' group shall be measured for insulation resistance and dielectric withstanding voltage.

#### Test:

1. Mate and measure contact resistance
2. Measure insulation resistance and dielectric withstanding voltage on group 15.
3. Measure mating and unmating forces
4. Expose connector to 100 cycles between -55°C and +100°C at 30 minutes per cycle.
5. Allow samples to recover for at least 1 hours and not more than 2 hours.
6. Measure contact resistance.
7. Measure insulation resistance and dielectric withstanding voltage on group 15.
8. Dry Heat: Expose connectors to 100°C for 16 hours (IEC 68-2-2, test Ba)
9. Measure insulation resistance during last hour of exposure.
10. Damp Heat: Expose to cyclic temperature/humidity (IEC 68-2-30, test Db). Upper Temperature 55°C. One 24 hour cycle
11. Cold: Transfer connectors immediately to -40°C for 16 hours
12. Damp Heat: Immediately transfer connectors to a 2nd damp heat cycle.
13. After 1 hour and less than 2 hours measure contact resistance. Measure insulation resistance and dielectric withstanding voltage on group 15.
14. Measure insertion/withdrawal forces.

	<b>TYPE</b> <b>PRODUCT SPECIFICATION</b>	<b>NUMBER</b> <b>GS-12-016</b> <b>(Was GES-12-016)</b>	
<b>TITLE</b> 72478, 72479, 74898, 74899, 84666, & Type Metral 5-Row Unshielded Cable Connectors		<b>PAGE</b> 18 of 30	<b>REVISION</b> D
		<b>AUTHORIZED BY</b> J. R. Volstorf	<b>DATE</b> 25-Apr-06
		<b>STATUS</b> <b>UNRESTRICTED</b>	

### 8.5 Vibration

Mated and headers and connectors must meet the requirements of IEC 1076-4-110 (Feb 97 draft) & IEC512, test 6d. A minimum of 100 contacts shall be measured in this test for contact resistance. Contact resistance shall not change by more than 5 milliohms.

Test:

1. Mate and measure contact resistance
2. Vibration: Expose to vibration
  - Sine wave, 10 to 2000 Hz, 200m/s<sup>2</sup> over 58Hz (20g)
  - 2 hour each direction, 3 axis (15 min. cycle)
  - Monitor events > 1µs
3. Measure contact resistance.

### 8.6 Vibration - Mechanical Shock

#### 8.6.1 Central Office Environment - IEC

Mated headers and connectors must meet the requirements of tests listed. A minimum of 100 contacts shall be measured in this test for contact resistance. Contact resistance shall not change by more than 5 milliohms.

Test:

1. Mate and measure contact resistance
2. Vibration: Expose to vibration per IEC 68-2-6, Test Fc
  - Sine wave, 10 to 500 Hz, 98m/s<sup>2</sup> over 58Hz (10g)
  - 1 octave/min. 2 hour each direction, 3 axis (15 min. cycle)
  - Monitor events > 10ns
3. Measure contact resistance.
4. Mechanical Shock: Expose to shock per IEC 68-2-27, Test Ea
  - Half sine wave, 490m/s<sup>2</sup> (50g)
  - 11ms, 6 shocks each direction, 3 axis
  - Monitor events > 10ns
5. Measure contact resistance

	<b>TYPE</b> <b>PRODUCT SPECIFICATION</b>	<b>NUMBER</b> <b>GS-12-016</b> <b>(Was GES-12-016)</b>	
	<b>TITLE</b> 72478, 72479, 74898, 74899, 84666, & Type Metral 5-Row Unshielded Cable Connectors	<b>PAGE</b> 19 of 30	<b>REVISION</b> D
		<b>AUTHORIZED BY</b> J. R. Volstorf	<b>DATE</b> 25-Apr-06
		<b>STATUS</b> <b>UNRESTRICTED</b>	

### 8.6.2 Central Office Environment - Bellcore

Mated headers and connectors must meet the requirements of Bellcore GR-1217-CORE. A minimum of 100 contacts shall be measured in this test for contact resistance. Contact resistance shall not change by more than 10 milliohms. A minimum of 10 contacts shall be measured for insulation resistance and dielectric withstanding voltage.

Test:

1. Measure mating and unmating forces
2. Mate and measure contact resistance
3. Measure insulation resistance and dielectric withstanding voltage on group 20.
4. Unmate and mate for 98 wear cycles. Apply DUST. Measure contact resistance
5. Vibration: Expose all samples to vibration per EIA-364-TP28B, TC II  
10 to 500 Hz, @ 10g peak  
2 hour each direction, 3 axis  
Monitor events > 10ns
6. Measure contact resistance.
7. Mech. Shock: Expose all samples to shock per EIA-364-TP27B, TC 1  
30g half sine wave  
3 shocks each direction, 3 axis (18 shocks)  
Monitor events > 10ns
8. Measure contact resistance
9. Measure insulation resistance and dielectric withstanding voltage on group 20.
10. Measure mating and unmating forces.

### Thermal Shock - Moisture Resistance

#### 8.7.1 Central Office Environment - Bellcore

Mated headers and connectors must meet the requirements of listed. A minimum of 100 contacts shall be measured in this test for contact resistance. Contact resistance shall not change by more than 10 milliohms. A minimum of 10 contacts shall be measured for insulation resistance and dielectric withstanding voltage.

Test:

1. Measure mating and unmating forces
2. Mate and measure contact resistance
3. Mate and measure insulation resistance and dielectric withstanding voltage on group 22.
4. Thermal Shock: Expose all samples to shock per EIA-364-TP32A, TC I  
-55°C to 85°C, 5 cycles, 30 minutes/cycle
5. Measure contact resistance.
6. On samples for contact resistance testing unmate and mate for 99 wear cycles. Apply DUST. Measure contact resistance
7. Moisture resistance: Expose all samples per EIA-364-TP31A, method III  
+25°C to 65°C, 50 cycles
8. Allow 24 hours for recovery
9. Measure contact resistance
10. Measure insulation resistance and dielectric withstanding voltage on group 22.

	<b>TYPE</b> <b>PRODUCT SPECIFICATION</b>	<b>NUMBER</b> <b>GS-12-016</b> <b>(Was GES-12-016)</b>	
	<b>TITLE</b> 72478, 72479, 74898, 74899, 84666, & Type Metral 5-Row Unshielded Cable Connectors	<b>PAGE</b> 20 of 30	<b>REVISION</b> D
		<b>AUTHORIZED BY</b> J. R. Volstorf	<b>DATE</b> 25-Apr-06
		<b>STATUS</b> <b>UNRESTRICTED</b>	

11. Measure mating and unmating forces.

### 8.7.2 Uncontrolled Environment - Bellcore

Mated and headers and connectors must meet the requirements of listed. A minimum of 100 contacts shall be measured in this test for contact resistance. Contact resistance shall not change by more than 10 milliohms. A minimum of 10 contacts shall be measured for insulation resistance and dielectric withstanding voltage.

Test:

1. Measure mating and unmating forces
2. Mate and measure contact resistance
3. Mate and measure insulation resistance and dielectric withstanding voltage.
4. Thermal Shock: Expose all samples to shock per EIA-364-TP32A, TC II -65°C to 105°C, 5 cycles, 30 minutes/cycle
5. Measure contact resistance.
6. On samples for contact resistance testing unmate and mate for 99 wear cycles. Apply DUST. Measure contact resistance
7. Moisture resistance: Expose all samples per EIA-364-TP31A, method III +5°C to 85°C, 50 cycles
8. Allow 24 hours for recovery
9. Measure contact resistance
10. Measure insulation resistance and dielectric withstanding voltage.
11. Measure mating and unmating forces.

## 9.0 QUALITY ASSURANCE PROVISIONS

### 9.1 Equipment Calibration

All test equipment and inspection facilities used in the performance of any text shall be maintained in a calibration system in accordance with BUS-01-040.

### 9.2 Inspection Conditions

Unless otherwise specified herein, all inspections shall be performed under the following conditions:

Temperature: 25° ± 5° C

Relative humidity: 30% to 60%

Barometric pressure: Local ambient

### 9.3 Sample Quantity and Description

The test sequence for the qualification testing of the connector and header and sample size are shown in Table 1. A minimum of ninety contacts will be selected equally from the connectors in each test group.

	TYPE	<b>PRODUCT SPECIFICATION</b>		NUMBER	<b>GS-12-016</b> (Was GES-12-016)			
	TITLE	72478, 72479, 74898, 74899, 84666, & Type Metral 5-Row Unshielded Cable Connectors		PAGE	21 of 30	REVISION	D	
				AUTHORIZED BY	J. R. Volstorf		DATE	25-Apr-06
				STATUS	<b>UNRESTRICTED</b>			

**Table 1 - Test Matrix: Except IDC only Tests**

		TEST GROUP							
		1	2	3	4	5	6	7	8
<b>QUANTITY OF CONNECTORS</b>									
72478-1XY 5X6 WITH 0.8um GOLD				6		4		4	
72478-2XY 5X6 WITH 2.0UM GOLD									
72478-3XY 5X6 WITH 1.3um GOLD									
72478-9XY 5X6 WITH 0.8um GXT		6	6		4		4		4
<b>QUANTITY OF HEADERS</b>									
89006-12Z 5X6 WITH 0.8um GOLD				6		4		4	
89006-51Z 5X6 WITH 1.3um GXT			6						
89006-92Z 5X6 WITH 0.8um GXT		6			4		4		4
<b>TEST</b>	<b>PARA</b>	<b>TEST SEQUENCE</b>							
EXAMINATION OF PRODUCT	3.1	1, 3	1, 3	1, 3	1, 3	1, 3	1, 3	1, 3	1, 5
<b><u>ELECTRICAL CHARACTERISTICS</u></b>									
CONNECTOR CONTACT RESISTANCE	6.1	X	X	X	X	X	X	X	
CURRENT CARRYING CAPACITY	6.2								2
INSULATION RESISTANCE <sup>2</sup>	6.3	X	X	X	X	X	X	X	
DIELECTRIC WITHSTANDING VOLTAGE <sup>2</sup>	6.4	X	X	X	X	X	X	X	
<b><u>MECHANICAL CHARACTERISTICS</u></b>									
MATING FORCE <sup>1</sup>	7.1	X	X	X			X	X	
UNMATING FORCE <sup>1</sup>	7.2	X	X	X			X	X	
CONTACT NORMAL FORCE	7.3	6	6	6					
IDC RETENTION ( 90° )	7.5								
COVER RETENTION	7.6	4	4	4			4	4	3
LATCH RETENTION	7.7						5	5	4
UNLATCHING MECHANISM	7.8				4	4			
INSULATOR RETENTION IN COVER	7.10	5	5	5			6	6	
<b><u>ENVIRONMENTAL CONDITIONS</u></b>									
THERMAL AGE <sup>1</sup> 100°C, 112 DAY	8.1.1	2	2	2					
THERMAL AGE 70°C, 1 AMP, 42 DAY	8.1.3				2	2			
H. HUMIDITY - 93%, 40°C FOR 56 DAYS	8.3						2	2	

1. Mating and unmating forces are to be measure in first and last steps of thermal age.
2. Insulation resistance and dielectric withstanding voltage are to be measured on different contacts.



TYPE

**PRODUCT SPECIFICATION**

NUMBER

**GS-12-016**  
(Was GES-12-016)

TITLE

72478, 72479, 74898, 74899, 84666, & Type Metral 5-Row Unshielded Cable Connectors

PAGE

22 of 30

REVISION

D

AUTHORIZED BY

J. R. Volstorf

DATE

25-Apr-06

STATUS

**UNRESTRICTED**

**Table 2 - Test Matrix: Except IDC only Tests - Continued**

**TEST GROUP**

		9	11	12	13	14	15	16
<b>QUANTITY OF CONNECTORS</b>								
72478-1XY 5X6 WITH 0.8um GOLD			4			4		4
72478-2XY 5X6 WITH 2.0UM GOLD								
72478-3XY 5X6 WITH 1.3um GOLD								
72478-9XY 5X6 WITH 0.8um GXT		4		4	4		4	
<b>QUANTITY OF HEADERS</b>								
89006-12Z 5X6 WITH 0.8um GOLD			4			4		4
89006-51Z 5X6 WITH 1.3um GXT					4			
89006-92Z 5X6 WITH 0.8um GXT		4		4			4	
<b>TEST</b>	<b>PARA</b>	<b>TEST SEQUENCE</b>						
EXAMINATION OF PRODUCT	3.1	1, 3	1, 3	1, 3	1, 3	1, 3	1, 3	1, 3
<b><u>ELECTRICAL CHARACTERISTICS</u></b>								
CONNECTOR CONTACT RESISTANCE	6.1	X	X	X	X	X	X	X
CURRENT CARRYING CAPACITY	6.2							
INSULATION RESISTANCE <sup>2</sup>	6.3				X		X	
DIELECTRIC WITHSTANDING VOLTAGE <sup>2</sup>	6.4				X		X	
<b><u>MECHANICAL CHARACTERISTICS</u></b>								
MATING FORCE <sup>1</sup>	7.1							
UNMATING FORCE <sup>1</sup>	7.2				4			
CONTACT NORMAL FORCE	7.3							
IDC RETENTION ( AXIAL )	7.4							
IDC RETENTION ( 90° )	7.5							
COVER RETENTION	7.6							
LATCH RETENTION	7.7							
UNLATCHING MECHANISM	7.8							
<b><u>ENVIRONMENTAL CONDITIONS</u></b>								
BATTELLE MIXED GAS CLASS II + SO <sub>2</sub>	8.2.1	2	2					
INDUSTRIAL CORROSION Ke - CO	8.2.2			2		2		
INDUSTRIAL CORROSION Ke - UE	8.2.3				2			
THERM. SHOCK -CLIMATIC SEQUENCE	8.4						2	2



TYPE

**PRODUCT SPECIFICATION**

NUMBER

**GS-12-016**  
(Was GES-12-016)

TITLE

72478, 72479, 74898, 74899, 84666, & Type Metral 5-Row Unshielded Cable Connectors

PAGE

23 of 30

REVISION

D

AUTHORIZED BY

J. R. Volstorf

DATE

25-Apr-06

STATUS

**UNRESTRICTED**

**Table 3 - Test Matrix: Except IDC only Tests - Continued**

**TEST GROUP**

		17	18	19	20	21	22	23	24
<b>QUANTITY OF CONNECTORS</b>									
72478-1XY 5X6 WITH 0.8um GOLD				4		4		4	
72478-2XY 5X6 WITH 2.0UM GOLD									
72478-3XY 5X6 WITH 1.3um GOLD									
72478-9XY 5X6 WITH 0.8um GXT		4	4		4		4		4
<b>QUANTITY OF HEADERS</b>									
89006-12Z 5X6 WITH 0.8um GOLD				4		4		4	
89006-51Z 5X6 WITH 1.3um GXT		4							4
89006-92Z 5X6 WITH 0.8um GXT			4		4		4		
<b>TEST</b>	<b>PARA</b>	<b>TEST SEQUENCE</b>							
EXAMINATION OF PRODUCT	3.1	1, 3	1, 3	1, 3	1, 3	1, 3	1, 3	1, 3	1, 3
<b><u>ELECTRICAL CHARACTERISTICS</u></b>									
CONNECTOR CONTACT RESISTANCE	6.1	X	X	X	X	X	X	X	X
CURRENT CARRYING CAPACITY	6.2								
INSULATION RESISTANCE <sup>2</sup>	6.3				X		X		X
DIELECTRIC WITHSTANDING VOLTAGE <sup>2</sup>	6.4				X		X		X
<b><u>MECHANICAL CHARACTERISTICS</u></b>									
MATING FORCE <sup>1</sup>	7.1				X	X	X	X	X
UNMATING FORCE <sup>1</sup>	7.2				X	X	X	X	X
CONTACT NORMAL FORCE	7.3								
IDC RETENTION ( AXIAL )	7.4								
IDC RETENTION ( 90° )	7.5								
COVER RETENTION	7.6								
LATCH RETENTION	7.7								
UNLATCHING MECHANISM	7.8								
<b><u>ENVIRONMENTAL CONDITIONS</u></b>									
VIBRATION	8.5	2							
VIBRATION-MECH. SHOCK - CO	8.6.1		2	2					
VIBRAT-MECH SHOCK - CO=BELLCORE	8.6.2				2	2			
THERM. SHOCK-MOIST. RESIST. - CO	8.7.1						2	2	
THERM. SHOCK-MOIST. RESIST. - UE	8.7.2								2

	<b>TYPE</b> <b>PRODUCT SPECIFICATION</b>	<b>NUMBER</b> <b>GS-12-016</b> <b>(Was GES-12-016)</b>	
	<b>TITLE</b> 72478, 72479, 74898, 74899, 84666, & Type Metral 5-Row Unshielded Cable Connectors	<b>PAGE</b> 24 of 30	<b>REVISION</b> D
		<b>AUTHORIZED BY</b> J. R. Volstorf	<b>DATE</b> 25-Apr-06
		<b>STATUS</b> <b>UNRESTRICTED</b>	

**Table 4 - Test Matrix: Except IDC only Tests - Continued**

		TEST GROUP							
		25	26	27	28	29	30		
<b>QUANTITY OF CONNECTORS</b>									
72387-XY1		4	4						
72387-XY2				4	4				
72478-XY1						10			
72479-XY1							10		
<b>DESCRIPTION OF WIRE OR CABLE</b>									
30 GAGE WIRE PER P/N 301600-001					X				
28 GAGE WIRE PER P/N 301599-001				X					
26 GAGE WIRE PER P/N 301595-001			X						
24 GAGE WIRE PER P/N 301594-001		X							
807A CABLE 16/26 (LUCENT) OR						X			
808A CABLE 32/26 (LUCENT) OR							X		
<b>TEST</b>	<b>PARA</b>	<b>TEST SEQUENCE</b>							
EXAMINATION OF PRODUCT	3.1	1,3	1,3	1,3	1,3	1,6	1,6		
<b>MECHANICAL CHARACTERISTICS</b>									
IDC RETENTION ( AXIAL )	7.4		2		2				
IDC RETENTION ( 90° )	7.5	2		2					
CONNECTOR-CABLE ROBUSTNESS	7.9.1					2	2		
CONNECTOR-CABLE ROTATION	7.9.2					3	3		
CONNECTOR-CABLE PULL	7.9.3					4	4		
CONNECTOR-CABLE TORSION	7.9.4					5	5		



	<b>TYPE</b> <b>PRODUCT SPECIFICATION</b>	<b>NUMBER</b> <b>GS-12-016</b> <b>(Was GES-12-016)</b>	
	<b>TITLE</b> 72478, 72479, 74898, 74899, 84666, & Type Metral 5-Row Unshielded Cable Connectors	<b>PAGE</b> 25 of 30	<b>REVISION</b> D
		<b>AUTHORIZED BY</b> J. R. Volstorf	<b>DATE</b> 25-Apr-06
		<b>STATUS</b> <b>UNRESTRICTED</b>	

**Table 5 - Test Matrix: Except IDC only Tests - Continued**

		TEST GROUP							
		31	32	33	34	35	36	37	38
<u>QUANTITY OF CONNECTORS</u>									
72478-xxx any configuration								10	10
84666-102 5X4 WITH 0.8um GOLD				10		10			
84667-102 5X16 WITH 0.8um GXT					10		10		
<u>QUANTITY OF HEADERS</u>									
84669-1001 5X16 WITH 0.8um GOLD									
<u>DESCRIPTION OF CABLE</u>									
1350A CABLE 8/26 (LUCENT) OR						X	X		
<b>TEST</b>	<b>PARA</b>	<b>TEST SEQUENCE</b>							
EXAMINATION OF PRODUCT	3.1			1, 3	1, 3	1, 6	1, 6	1, 3	1,4
<u>ELECTRICAL CHARACTERISTICS</u>									
CONNECTOR CONTACT RESISTANCE	6.1								
<u>MECHANICAL CHARACTERISTICS</u>									
COVER RETENTION	7.6			7	7				
LATCH RETENTION	7.7			5	5				5
UNLATCHING MECHANISM	7.8			4	4			2	3
CONNECTOR CABLE ROBUSTNESS	7.9.1					2	2		
CONNECTOR CABLE ROTATION	7.9.2					3	3		
CONNECTOR CABLE PULL	7.9.3					4	4		
CONNECTOR CABLE TORSION	7.9.4					5	5		
INSULATOR RETENTION IN COVER	7.10			6	6				
<u>ENVIRONMENTAL CONDITIONS</u>									
THERMAL AGE	8.1.4			2	2				2
VIBRATION-MECH. SHOCK - CO	8.6.1								

	<b>TYPE</b> <b>PRODUCT SPECIFICATION</b>	<b>NUMBER</b> <b>GS-12-016</b> <b>(Was GES-12-016)</b>	
	<b>TITLE</b> 72478, 72479, 74898, 74899, 84666, & Type Metral 5-Row Unshielded Cable Connectors	<b>PAGE</b> 26 of 30	<b>REVISION</b> D
		<b>AUTHORIZED BY</b> J. R. Volstorf	<b>DATE</b> 25-Apr-06
		<b>STATUS</b> <b>UNRESTRICTED</b>	

**Table 6 - Test Matrix: IDC only Tests**

		<b>TEST GROUP</b>									
<b>QUANTITY OF CONNECTORS</b>		A	B	C	D	E	F	G	H		
72384-W01 2X5 CONN. SUB-		8	8	8						8	
72384-W02 2X5 CONN. SUB-					8	8	8	8			
72384-W01 2X5 WITH Ni PLATE											
72384-W02 2X5 WITH Ni PLATE											
<b>WIRE SPECIFICATION</b>											
UNINSULATED TINNED 30 GAGE					X						
UNINSULATED TINNED 28 GAGE						X					
UNINSULATED TINNED 26 GAGE		X									
30 GAGE PER P/N 301600-001							X				
28 GAGE PER P/N 301599-001								X			
26 GAGE PER P/N 301595-001			X								
24 GAGE PER P/N 301594-001				X							
26 GAGE WITH .032" DIA. MD-PE									X		
<b>TEST</b>	<b>PARA</b>	<b>TEST SEQUENCE</b>									
EXAMINATION OF PRODUCT	3.1	1 , 3	1, 3	1 , 3	1 , 3	1 , 3	1 , 3	1 , 3	1 , 3	1 , 3	
<b>ENVIRONMENTAL CONDITIONS</b>											
THERMAL AGE <sup>1</sup> 100°C, 112 DAY	8.1.2	2	2	2	2	2	2	2	2	2	

**9.4 Acceptance**

Electrical and mechanical requirements placed on test samples as indicated in the sections of this specification shall be established from test data using appropriate statistical techniques or shall otherwise be customer specified, and all samples tested in accordance with the product specification shall meet these requirements.

Failures attributed to equipment, test set-up or operator error shall not disqualify the product. If product failure occurs, corrective action shall be taken and samples resubmitted for qualification.

**9.5 Qualification Testing**

Qualification testing shall be performed on connectors and headers produced with equipment and procedures normally used in production.

	<b>TYPE</b> <b>PRODUCT SPECIFICATION</b>	<b>NUMBER</b> <b>GS-12-016</b> <b>(Was GES-12-016)</b>	
	<b>TITLE</b> 72478, 72479, 74898, 74899, 84666, & Type Metral 5-Row Unshielded Cable Connectors	<b>PAGE</b> 27 of 30	<b>REVISION</b> D
		<b>AUTHORIZED BY</b> J. R. Volstorf	<b>DATE</b> 25-Apr-06
		<b>STATUS</b> <b>UNRESTRICTED</b>	

### 9.6 Requalification Testing

If any of the following conditions occur, the responsible product engineer shall initiate requalification testing consisting of all applicable parts of the qualification test matrix, Table 1.

1. A significant design change is made to the existing product which impacts the product form, fit or function. Examples of significant changes shall include, but not be limited to, changes in the plating, material composition or thickness, contact force, pin/contact surface geometry, insulator or housing design, pin/contact base material or pin/contact lubrication.
2. A significant change is made to the manufacturing process which impacts the product form, fit or function.
3. A significant event occurs during production or end use requiring corrective action to be taken relative to the product design or manufacturing process

### 10.0 NOTES

The following table list the cad files imported into this document.

Figure	Autocad File
1	G12016_A
2	G12016_B
3	G12016_C
4	G12016_D
5	G12016_E
6	G12016_F
7	G12016_G
8	G12016_H

### 11.0 REFERENCE DOCUMENTS

The following documents, of the issue in effect of the date of the latest revision of this specification, shall form a part of this specification to the extent specified herein.

	<b>TYPE</b> <b>PRODUCT SPECIFICATION</b>	<b>NUMBER</b> <b>GS-12-016</b> <b>(Was GES-12-016)</b>	
	<b>TITLE</b> 72478, 72479, 74898, 74899, 84666, & Type Metral 5-Row Unshielded Cable Connectors	<b>PAGE</b> 28 of 30	<b>REVISION</b> D
		<b>AUTHORIZED BY</b> J. R. Volstorf	<b>DATE</b> 25-Apr-06
		<b>STATUS</b> <b>UNRESTRICTED</b>	

FCI Documents

### 11.1.1 Product Drawings

Drawing Number	Description
70289	Latch Finger ( Standard )
72383	Contact, Blank & Plate
72384	Contact, Formed
72386	2x5 Insulator
72387	2x5 Connector Sub-Assembly, Standard
72388	Coding Keys
72389	Short Latch Finger
72390	5x6 Covers, Standard
72478	5x6 Cable Connector, Standard
72479	5x12 Cable Connector, Standard
72512	5x12 Covers
74458	2x5 Insulator
74459	2x5 Connector Sub-Assembly, Specials
74897	2x5 Connector Sub-Assembly, Specials
74898	5x6 Cable Connector, Specials
74899	5x12 Cable Connector, Specials
84663	5x4 Covers, Specials
84664	5x16 Covers, Specials
84665	Latch Finger, Specials
84666	5x4 Cable Connector, Specials
84667	5x16 Cable Connector, Specials

### 11.1.2 Process Specifications

Specification	Description
BUS-01-040	VG Site Equipment Calibration Guidelines
BUS-03-404	Normal Force Measurements
BUS-03-601	Current Rating/ 30° C Temperature Rise
BUS-15-002	Nickel Plating
GS-20-001	Tin ( Lead Free ) Plating
BUS-15-006	Tin/Lead Plating
BUS-15-005	Palladium Nickel Alloy Plating
BUS-15-008	Gold in Contact Plating
BUS-19-002	Solderability
BUS-19-020	Porosity, Plating
BUS-19-040	Adhesion, Plating
GS-20-003	Application, Cable Connector Assembly
GS-20-007	Application, Cable Connector Assembly

	<b>TYPE</b> <b>PRODUCT SPECIFICATION</b>	<b>NUMBER</b> <b>GS-12-016</b> <b>(Was GES-12-016)</b>	
	<b>TITLE</b> 72478, 72479, 74898, 74899, 84666, & Type Metral 5-Row Unshielded Cable Connectors	<b>PAGE</b> 29 of 30	<b>REVISION</b> D
		<b>AUTHORIZED BY</b> J. R. Volstorf	<b>DATE</b> 25-Apr-06
		<b>STATUS</b> <b>UNRESTRICTED</b>	

## 11.2 Other Standards and Specifications

UL94-V0: Tests for Flammability of Plastic Materials in Devices and Appliances

IEC 512: International Electrical Commission Standards

IEC 1076:

X-20954: Lucent Technologies Specification "Qualification Requirements for Separable and Non-Separable Electro-Mechanical Connections"

GR-1089-CORE: Bellcore Specification "Electromagnetic Compatibility and Electrical Safety - Generic Criteria for Network telecommunications Equipment"

GR-1217-CORE: Bellcore Specification "Generic Requirements for Separable Electrical Connectors"

EIA 364: Electrical Connector/Socket Test Procedures Including Environmental Classifications

## 11.3 Lab Reports - Supporting Data

- AT&T Internal Memorandum #536140000-940519-01IM, "X-20462 Thermal Age Qualification of 100 gram Normal Force - 2mm IDC Cable Connector"
- AT&T Internal Memorandum #536140000-940411-01IM, "X-20462 Vibration and Shock Qualification of 100 gram Normal Force - 2mm IDC Cable Connector"
- AT&T Internal Memorandum #536140000-940425-01IM, "X-20462 Temperature Cycling and Insertion Force Qualification of 100 gram Normal Force - 2mm IDC Cable Connector"
- AT&T Internal Memorandum #536140000-940512-01IM, "X-20462 Atmospheric Corrosion Qualification of 100 gram Normal Force - 2mm IDC Cable Connector"

## 12.0 EQUIVALENT QUALIFICATION TESTING

If the equivalent tests as specified for test groups 1 through 24 in this specification are conducted on cable connectors per product specification GS-12 -15 or for test groups 9 through 24 per product specification GS-12-108, then that shall be considered as the same as having tested the product per this specification. If the equivalent tests as specified for test groups A through G in this specification are conducted on cable connectors per product specification GS-12-108, then that shall be considered as the same as having tested the product per this specification. In addition if other wire types are tested per specification GS-12-108 to the equivalent of section 8.1.2 of this specification, then that shall be considered as having qualified additional wire types per this specification.

	TYPE <b>PRODUCT SPECIFICATION</b>	NUMBER <b>GS-12-016</b> (Was GES-12-016)	
TITLE 72478, 72479, 74898, 74899, 84666, & Type Metral 5-Row Unshielded Cable Connectors		PAGE 30 of 30	REVISION D
		AUTHORIZED BY J. R. Volstorf	DATE 25-Apr-06
		STATUS <b>UNRESTRICTED</b>	

**REVISION RECORD**

REV	PAGE	DESCRIPTION	EC #	DATE
A	ALL	NEW DOCUMENT	V94307	10/29/99
B	ALL	Revised format to be consistent with GS-01-001, and change BERG, Dupont, etc. references to FCI. Change document number prefix from GES to GS.	V01949	08/15/00
C	ALL	Add lead free information	V05-0940	10/05/05
D	ALL	Change logo	V06-0404	4/25/06