	Type PRODUCT SPECIFICATION	GS-12-406	
TITLE: MicroTCA POWER I/O CONNECTOR PCB MALE CONNECTOR		PAGE 1 of 27	REV. A
		AUTHORIZED BY SINESH	DATE (yy/mm/dd) 2007/01/10

48V-PCB DUAL CONNECTOR

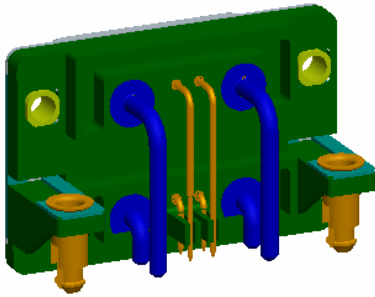

**PCB MALE CONNECTOR-
SOLDER TO BOARD**

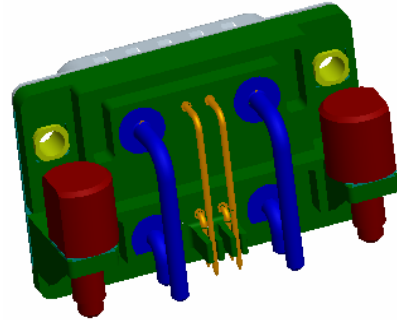

**PCB MALE CONNECTOR
PIP CONNECTOR**

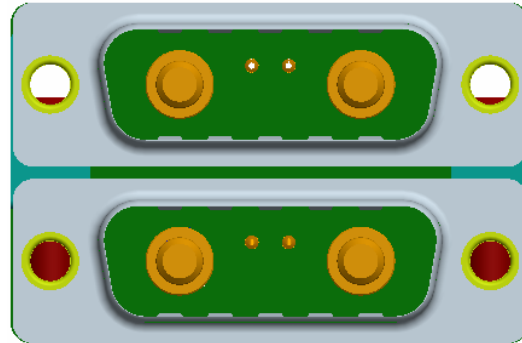

Connector mating side view.

NOTE: THIS DOCUMENT IS THE PROPERTY OF AND EMBODIES PROPRIETARY INFORMATION OF THE FCI CDC COMPANY. NO PART OF THE INFORMATION SHOWN ON THIS DOCUMENT MAY BE USED IN ANY WAY WITHOUT THE WRITTEN CONSENT OF FCI CDC.

	Type PRODUCT SPECIFICATION	GS-12-406	
TITLE: MicroTCA POWER I/O CONNECTOR PCB MALE CONNECTOR		PAGE 2 of 27	REV. A
		AUTHORIZED BY SINESH	DATE (yy/mm/dd) 2007/01/10

48V-PCB SINGLE CONNECTOR

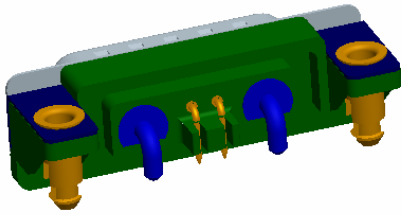

**PCB MALE CONNECTOR-
SOLDER TO BOARD**

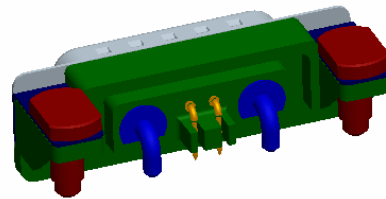

**PCB MALE CONNECTOR
PIP CONNECTOR**

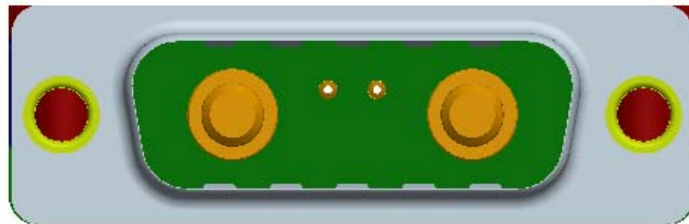

Connector mating side view.

NOTE: THIS DOCUMENT IS THE PROPERTY OF AND EMBODIES PROPRIETARY INFORMATION OF THE FCI CDC COMPANY. NO PART OF THE INFORMATION SHOWN ON THIS DOCUMENT MAY BE USED IN ANY WAY WITHOUT THE WRITTEN CONSENT OF FCI CDC.

 CDC <small>TITLE:</small>	<small>Type</small> PRODUCT SPECIFICATION	GS-12-406	
	MicroTCA POWER I/O CONNECTOR PCB MALE CONNECTOR	<small>PAGE</small> 3 of 27	<small>REV.</small> A
<small>AUTHORIZED BY</small> SINESH		<small>DATE (yy/mm/dd)</small> 2007/01/10	

CONTENTS

1. Scope 4

2. Applicable documents..... 4

3. Product description 6

 3.1 General 6

 3.2 Design and construction 6

 3.3 Materials and plating 6

 3.3.1 Housing dielectric material..... 6

 3.3.2 Terminal material 6

 3.3.3 Terminal Plating 6

 3.3.4 Shell material 6

 3.3.5 Shell Plating 6

 3.3.6 Accessory Material..... 6

 3.3.7 Accessory Plating 6

4. Characteristics & Test schedule 8

 4.1 Characteristics 8

 4.1.1 Environmental Characteristics 8

 4.1.2 Electrical Characteristics..... 8

 4.1.3 Mechanical Characteristics..... 8

 4.2 Test schedule..... 9

 4.2.1 Specimen measurement arrangements..... 9

 4.2.2 Test Schedule Table..... 9

 4.2.2.1 Test Group A - Mixed Flowing Gas 9

 4.2.2.2 Test Group B - Mechanical Endurance and Dust 9

 4.2.2.3 Test Group C - Thermal Shock & Moisture..... 9

 4.2.2.4 Test Group D - High Temperature&Electrical load..... 9

 4.2.2.5 Test Group E - Electrical Load Temperature rise..... 9

 4.3 Accessories..... 9

5. Reflow process 26

 Lead free soldering 26

6. Packaging 26

7. Revision record 27

NOTE: THIS DOCUMENT IS THE PROPERTY OF AND EMBODIES PROPRIETARY INFORMATION OF THE FCI CDC COMPANY. NO PART OF THE INFORMATION SHOWN ON THIS DOCUMENT MAY BE USED IN ANY WAY WITHOUT THE WRITTEN CONSENT OF FCI CDC.

 CDC <small>TITLE:</small>	<small>Type</small> PRODUCT SPECIFICATION	GS-12-406	
	MicroTCA POWER I/O CONNECTOR PCB MALE CONNECTOR	<small>PAGE</small> 4 of 27	<small>REV.</small> A
<small>AUTHORIZED BY</small> SINESH		<small>DATE (yy/mm/dd)</small> 2007/01/10	

1. Scope

This Product specification covers the requirements of a **µTCA Telecom Customers & FCI D-SUB** requirements.

2. Applicable documents

Specification or Standards Body	Specification or Standard #	Description	Note
Telcordia	GR-1 21 7-CORE	Generic requirements for separable electrical connectors used in telecommunications hardware	
IEC	60664-1	Insulation coordination for equipment within low-voltage systems	Section: 3.2. 42
	605124-1	Voltage stress tests -Voltage Proof	
	60512-5-2	Current carrying capacity tests -Current temperature derating	
	60512-2-1	Electrical continuity and contact resistance tests -Contact resistance millivolt level method	
	60 512-3-1	Insulation tests -Insulation resistance	
	60512-234	Screening and filtering tests -Transmission line reflections in the time domain	
	60512-25-5	Tests and measurements -Return loss	
	60512-25-2	Tests and measurements - Attenuation (insertion loss)	

Specification or Standards Body	Specification or Standard #	Description	Note
IEC	60512-25.1	Tests and measurements -Crosstalk	

NOTE: THIS DOCUMENT IS THE PROPERTY OF AND EMBODIES PROPRIETARY INFORMATION OF THE FCI CDC COMPANY. NO PART OF THE INFORMATION SHOWN ON THIS DOCUMENT MAY BE USED IN ANY WAY WITHOUT THE WRITTEN CONSENT OF FCI CDC.

 CDC <small>TITLE:</small>	<small>Type</small> PRODUCT SPECIFICATION	GS-12-406	
	MicroTCA POWER I/O CONNECTOR PCB MALE CONNECTOR	<small>PAGE</small> 5 of 27	<small>REV.</small> A
		<small>AUTHORIZED BY</small> SINESH	<small>DATE (yy/mm/dd)</small> 2007/01/10

	605 12-5	Endurance tests -Mechanical Operation	Section: Test 9a
	60512-13-1	Basic testing and measurements -Engaging and separating forces	
	60512-8	Mechanical tests on contacts and terminations -Gauge retention force	Section: Test 16e
	60512-6-4	Dynamic stress tests -Vibration	
	60512-6-3	Dynamic stress tests •Shock	
	60512-1-1	General examination -Visual examination	
	60950-1	Safety -General requirements	Section 2.1.1.1: Access to energized parts
	60664-1	Insulation coordination of equipment within low-voltage systems	Section 2.5.1: Degrees of pollution in the micro-environment
EIA	364-31	Humidity test procedure for electrical connectors	
	364-32	Thermal shock test procedure for electrical connectors	
	364-91	Dust test for electrical connectors and sockets	
	365-65	Mixed flowing gas	
	364-04	Normal force test procedure for electrical connectors	
	364-17	Temperature life with or without electrical load test procedure for electrical connectors and sockets	
RoHS	2002/95/EC	Restriction of the use of certain Hazardous Substances in electrical and electric equipment	

3. Product description

3.1 General

PRODUCT LEAD FREE IN ACCORDANCE TO RoHS 2002/EC/95
UL 94 V0 :E118235(R)

 CDC <small>TITLE:</small>	<small>Type</small> PRODUCT SPECIFICATION	GS-12-406	
	MicroTCA POWER I/O CONNECTOR PCB MALE CONNECTOR	<small>PAGE</small> 6 of 27	<small>REV.</small> A
<small>AUTHORIZED BY</small> SINESH		<small>DATE (yy/mm/dd)</small> 2007/01/10	

This connector is mounted on the front side of the power module and is connected to the external female power cable. 48V/24A type PCB Connector
 The connector mounted on the front panel and the contacts are connected to the internal PCB.
 Connector is with 2 power & 2 signal angled contacts for power monitoring.

3.2 Design and construction

The connector shall be of design, construction and physical dimensions as specified on the applicable product customer drawings :

Customer Drawings :

- 1) 48V PCB DUAL (Solder to Board) :- 10070158-001
- 2) 48V PCB DUAL (PIP) :- 10070158-002
- 3) 48V PCB SINGLE (Solder to Board) :- 10070158-003
- 4) 48V PCB SINGLE (PIP) :- 10070158-004

ORDERING INFORMATION

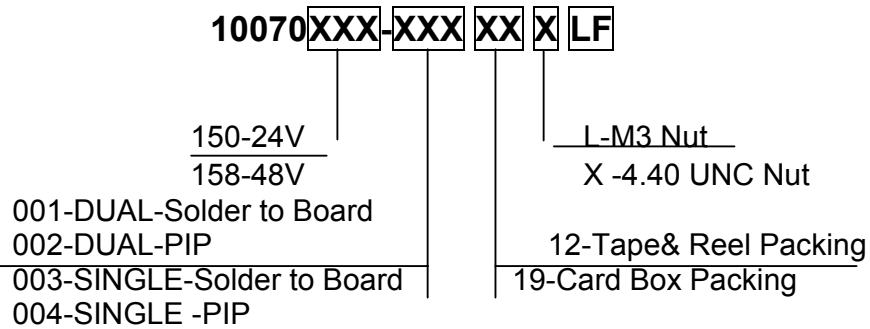

NOTE: THIS DOCUMENT IS THE PROPERTY OF AND EMBODIES PROPRIETARY INFORMATION OF THE FCI CDC COMPANY. NO PART OF THE INFORMATION SHOWN ON THIS DOCUMENT MAY BE USED IN ANY WAY WITHOUT THE WRITTEN CONSENT OF FCI CDC.

 FCI CDC	Type PRODUCT SPECIFICATION	GS-12-406	
MicroTCA POWER I/O CONNECTOR PCB MALE CONNECTOR		PAGE 7 of 27	REV. A
		AUTHORIZED BY SINESH	DATE (yy/mm/dd) 2007/01/10

48V PCB DUAL CONNECTOR

General mating Dimensions

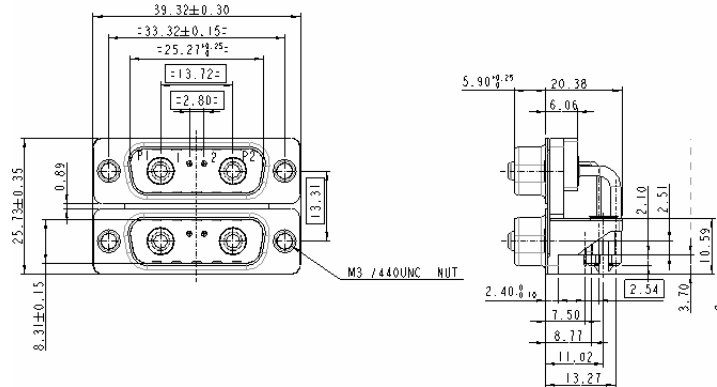
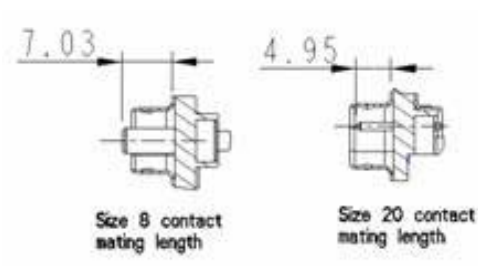

48V PCB SINGLE CONNECTOR

General mating Dimensions

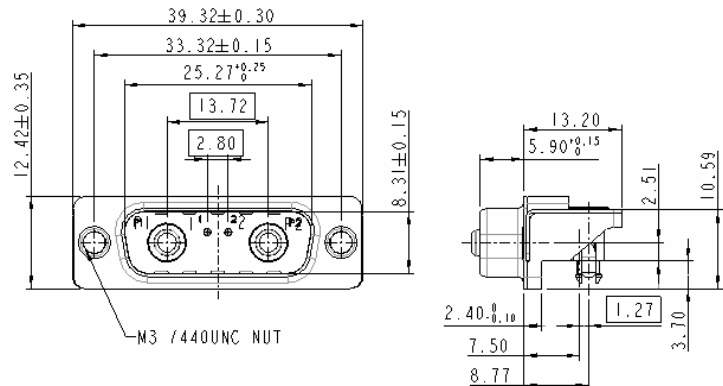
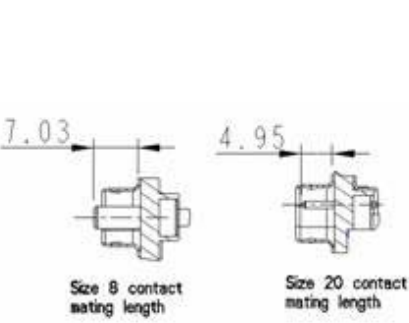

See Customer drawing for more details:-

3.3 Materials and plating

3.3.1 Housing dielectric material

Plastic raw material: Genestar 33% GF, UL94 V-O rating
Black color

3.3.2 Terminal material

Power contact Termination :- **Brass**
Power contact Active :- **Brass**
Signal Contacts :- **Brass**

3.3.3 Terminal Plating

Power termination : Sn over Cu
Power active : Cu + Ni + Au

NOTE: THIS DOCUMENT IS THE PROPERTY OF AND EMBODIES PROPRIETARY INFORMATION OF THE FCI CDC COMPANY. NO PART OF THE INFORMATION SHOWN ON THIS DOCUMENT MAY BE USED IN ANY WAY WITHOUT THE WRITTEN CONSENT OF FCI CDC.
E-3005 04/14/99

 CDC <small>TITLE:</small>	<small>Type</small> PRODUCT SPECIFICATION	GS-12-406	
	MicroTCA POWER I/O CONNECTOR PCB MALE CONNECTOR	<small>PAGE</small> 8 of 27	<small>REV.</small> A
<small>AUTHORIZED BY</small> SINESH		<small>DATE (yy/mm/dd)</small> 2007/01/10	

Signal contact : Au

3.3.4 Shell material

Steel

3.3.5 Shell Plating

Nickel

3.3.6 Accessory Material

Riveted Quality Brass for Clinch Nut
Metal Bracket : Phosphor Bronze
Harpoon : Brass
LIF Harpoon : Brass

3.3.7 Accessory Plating

Riveted Quality Brass for Clinch Nut : Nickel
Metal Bracket : Phosphor Bronze : Nickel
Harpoon : Brass : Tin over Nickel
LIF Harpoon : Brass Tin over Nickel

4. Characteristics & Test schedule

4.1 Characteristics

4.1.1 Environmental Characteristics

- Operating Temperature : 70°; + 30° temperature rise.
- Temperature Range : -50°C to 125 °C
- Self Existing capacity of plastics : UL V0
- Damp Heat Steady state : 21 days
- Salt Spray : 48 hours
- Resistance to atmospheric corrosion : Std Requirement for telecom

4.1.2 Electrical Characteristics

- Max. Current rating / contact (IEC 60512-5-2) : 48V – 24A (Power contact) - Temperature rise 30° :0.375A (Signal contact)
- Creepage clearance (IEC-60 664-1) : Between all cts and shells 1.5 except between Signal cts: 0.4.

 CDC <small>TITLE:</small>	Type PRODUCT SPECIFICATION	GS-12-406	
	MicroTCA POWER I/O CONNECTOR PCB MALE CONNECTOR	PAGE 9 of 27	REV. A
AUTHORIZED BY SINESH		DATE (yy/mm/dd) 2007/01/10	

- Insulation voltage : 1000 Vrms
(IEC-60512-4-1)
- Contact Resistance : ≤10 milli Ohms (Power)
: ≤25 milli Ohms (Power)
(IEC-60512-2-1)
- Insulation Resistance : 5000 MΩ initial / 500 MΩ after tests (under 1000 V)
(IEC-60512-3-1)
- Hot swap : Yes , but with signal contacts monitoring (first break/last mate)
- Engagement under electrical load : 200 cycles -5V at 0.2A

4.1.3 Mechanical Characteristics

- Mechanical operation : 200 mating cycles (Speed -10mm/sec max.)
- Engaging & Separating forces : Maximum Engaging force -100N
: Maximum Separating force -65N
- Max. Bottoming force : 200N at one minute duration of insertion
- Vibration : 10-500 Hz 50 m/s² 3 x8 x 3 axis 1 μs monitoring
- Shock : 300 m/s² 11 ms 1 μs monitoring
- Contact diameter on active area : 3.6mm (Power contact)
: 1.0mm (signal contact)

4.2 Test Schedule

- ❖ This section defines 5 groups of connector test requirements referred from GR-12-17-CORE. These applicable to all connector mounted on a Micro TCA system.
- Test Group A - Mixed Flowing Gas
- Test Group B - Mechanical Endurance and Dust
- Test Group C - Thermal Shock & Moisture
- Test Group D - High Temperature
- Test Group E - Electrical Load Temperature Rise

4.2.1 Specimen measurement arrangements

- Set 1: Contact Resistance measurement arrangement.
- Set 2: Insulation Resistance & Voltage –proofing measurement arrangement.
- Set 3: Current carrying measurement arrangement.

	Type PRODUCT SPECIFICATION	GS-12-406	
TITLE: MicroTCA POWER I/O CONNECTOR PCB MALE CONNECTOR		PAGE 10 of 27	REV. A
		AUTHORIZED BY SINESH	DATE (yy/mm/dd) 2007/01/10

- Set 4: Contact Disturbance measurement arrangement.
- Set 5: Shock & Vibration test setup.
- ✚ Set 1: Power Module Input Connector contact resistance measurement arrangement:

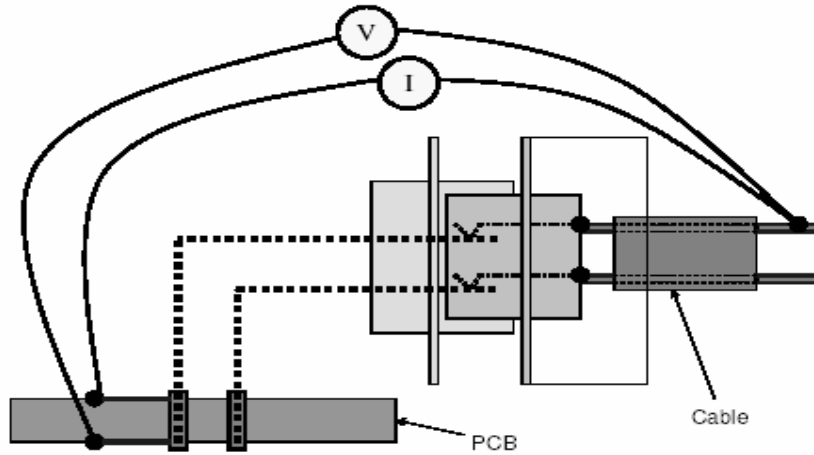

- ✚ Set 2: Power Module Input Connector insulation resistance and voltage-proof measurement arrangement:

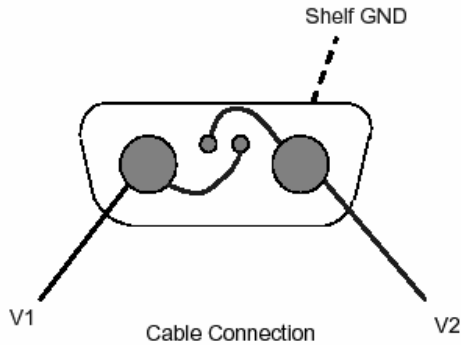

- ✚ Set 3: Power Module Input Connector current-carrying capacity measurement arrangement.

	Type PRODUCT SPECIFICATION	GS-12-406	
TITLE: MicroTCA POWER I/O CONNECTOR PCB MALE CONNECTOR		PAGE 11 of 27	REV. A
		AUTHORIZED BY SINESH	DATE (yy/mm/dd) 2007/01/10

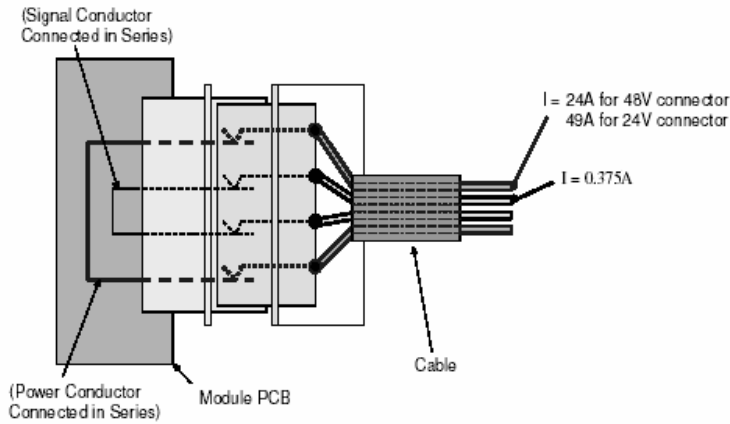

✚ Set 4: Power Module Input Connector contact disturbance measurement arrangement.

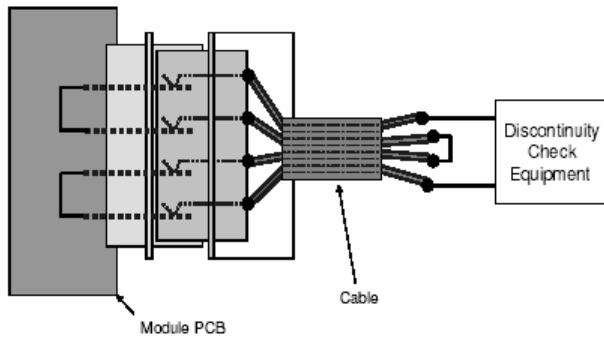

✚ Set 5 :Power Module Input Connector shock/vibration test setup.

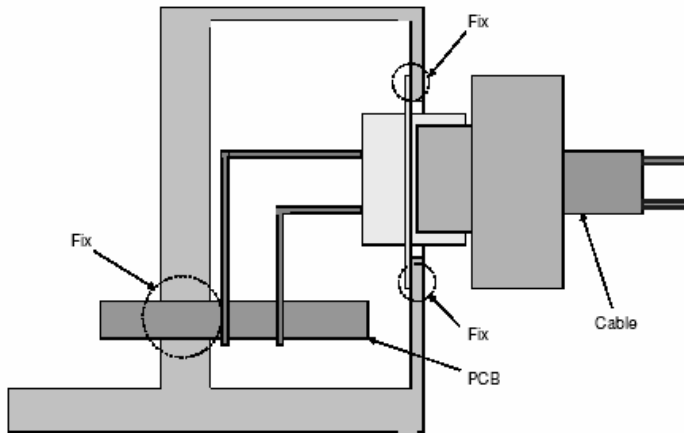

 FCJ CDC	Type	PRODUCT SPECIFICATION		GS-12-406	
	TITLE: MicroTCA POWER I/O CONNECTOR PCB MALE CONNECTOR			PAGE	REV.
			12 of 27	A	
			AUTHORIZED BY	DATE (yy/mm/dd)	
			SINESH	2007/01/10	

4.2.2 Test Schedule Table

 Number of specimen on each test Group

<u>Test groups</u>	<u>Measurement arrangement</u>					
	<u>Total</u>	<u>Set 1</u>	<u>Set 2</u>	<u>Set 3</u>	<u>Set 4</u>	<u>Set 5</u>
<u>Group A</u>	<u>7</u>	<u>4</u>	<u>3</u>			
<u>Group B</u>	<u>12</u>	<u>4</u>	<u>3</u>		<u>3</u>	<u>2</u>
<u>Group C</u>	<u>10</u>	<u>4</u>	<u>3</u>		<u>3</u>	
<u>Group D</u>	<u>7</u>	<u>4</u>	<u>3</u>			
<u>Group E</u>	<u>3</u>			<u>3</u>		

4.2.2.1 Group A - Mixed flowing gas test:-

 Mixed flowing gas testing sequence

Test phase	Title	Specimen	Severity /Condition of test	Measurement to be performed.	Ref. Standard	Requirements
A1	General examination	Set 1 Set 2	Unmated & un mounted connectors	Visual examination	IEC 60512-1-1	There shall be no defect that would impair normal operation.
A2	Contact normal force	Set 1		Contact Force	EIA-364-04	This is for design verification purpose and no requirement. (Preferred = 0.98 N minimum)
A3	Engaging/ Separating Force	Set 2	Speed = 10 mm/s max. Plug-in card insertion and extraction	Engaging and separating forces	IEC 60512-13-1	Maximum engaging force 100 N Maximum separating force 65 N Maximum bottoming force 200 N
A4	Insulation test	Set 2	Standard atmospheric conditions & Mated Condition	insulation resistance	IEC 60512-3-1	5000 MΩ initial / 500 MΩ after tests (under 1000 V)

 CDC <small>TITLE:</small>	<small>Type</small> PRODUCT SPECIFICATION	GS-12-406	
	MicroTCA POWER I/O CONNECTOR PCB MALE CONNECTOR		<small>PAGE</small> 13 of 27
<small>AUTHORIZED BY</small> SINESH			<small>DATE (yy/mm/dd)</small> 2007/01/10

A5	Voltage stress tests	Set 2	Standard atmospheric conditions & Mated Condition	Voltage-proof	IEC 60512-4-1	1000 Vrms
A6	Contact Resistance	Set 1	Max. voltage = 20 mV in open circuit Max. current = 100 mA	Contact Resistance	IEC 60512-2-1	≤10 milli Ohms (Power) ≤25 milli Ohms (Power)
A7	Mechanical Operation	Set 1 Set 2	Speed = 10 mm/s max. Rest 5 s (unmated) Initial 100 operations	Pre-wear	IEC60512-5.9a	
		Set 1	Max. voltage = 20 mV in open circuit Max. current = 100 mA	Contact resistance	IEC 60512-2-1	≤10 milli Ohms (Power) ≤25 milli Ohms (Power)
A8	High Temperature (Optional)	Set 1 Set 2	Mated Connectors Ambient temperature 105° C No electrical load Duration 300 h Recovery time 2 h	Temperature Life	EIA-364-17	This section is out of GR-1217-CORE requirement, but preferred to add for tighter environment application use
		Set 1	Max voltage = 20 mV in open circuit Max current = 100 mA	Contact resistance	IEC 60512-2-1	This section is out of GR-1217-CORE requirement, but preferred to add for tighter environment application use ≤10 milli Ohms (Power) ≤25 milli Ohms (Power)

 CDC <small>TITLE:</small>	<small>Type</small> PRODUCT SPECIFICATION	GS-12-406	
	MicroTCA POWER I/O CONNECTOR PCB MALE CONNECTOR		<small>PAGE</small> 14 of 27
<small>AUTHORIZED BY</small> SINESH			<small>DATE (yy/mm/dd)</small> 2007/01/10

A9	Corrosion industrial atmosphere	Set 1 Set 2	Set 1 Set 2 Central office environmental applications: Connector 5 days NO2: 200ppb(+/-50) Cl2: 10ppb(+/-3) H2S:10ppb(+/-5) SO2: 100ppb(+/-20) Uncontrolled environment application: Unmated Connector 5 days NO2: 200ppb(+/-50) Cl2: 20ppb(+/-5) H2S:100ppb(+/-20) SO2: 200ppb(+/-50)	Mixed flowing gas	EIA-364-65 Class IIA/ IIIA	
		Set 1	Max. voltage = 20 mV in open circuit Max. current = 100 mA	Contact Resistance	IEC 60512-2-1	≤10 milli Ohms (Power) ≤25 milli Ohms (Power)

NOTE: THIS DOCUMENT IS THE PROPERTY OF AND EMBODIES PROPRIETARY INFORMATION OF THE FCI CDC COMPANY. NO PART OF THE INFORMATION SHOWN ON THIS DOCUMENT MAY BE USED IN ANY WAY WITHOUT THE WRITTEN CONSENT OF FCI CDC.

 CDC TITLE:	Type	PRODUCT SPECIFICATION	GS-12-406	
	MicroTCA POWER I/O CONNECTOR PCB MALE CONNECTOR		PAGE	REV.
AUTHORIZED BY			DATE (yy/mm/dd)	
		SINESH	15 of 27	A
			2007/01/10	

		Set 1 Set 2	Set 1 Set 2 Central office environmental applications: Connector 5 days NO2: 200ppb(+/-50) Cl2: 10ppb(+/-3) H2S:10ppb(+/-5) SO2: 100ppb(+/-20) Uncontrolled environment application: Unmated Connector 5 days NO2: 200ppb(+/-50) Cl2: 20ppb(+/-5) H2S:100ppb(+/-20) SO2: 200ppb(+/-50)	Mixed flowing gas	EIA-364-65 Class IIA/ IIIA	
		Set 1	Max. voltage = 20 mV in open circuit Max. current = 100 mA	Contact Resistance	IEC 60512-2-1	≤10 milli Ohms (Power) ≤25 milli Ohms (Power)
		Set 1 Set 2	Uncontrolled environment application: Mated Connector 5 days. NO2: 200ppb(+/-50) Cl2: 20ppb(+/-5) H2S:100ppb(+/-20) SO2: 200ppb(+/-50)	Mixed flowing gas	EIA-364-65 Class IIIA	This section is applied only for uncontrolled environment application test.
		Set 1	Max. voltage = 20 mV in open circuit Max. current = 100 mA	Contact Resistance	IEC 60512-2-1	This section is applied only for uncontrolled environment application test. ≤10 milli Ohms (Power) ≤25 milli Ohms (Power)

NOTE: THIS DOCUMENT IS THE PROPERTY OF AND EMBODIES PROPRIETARY INFORMATION OF THE FCI CDC COMPANY. NO PART OF THE INFORMATION SHOWN ON THIS DOCUMENT MAY BE USED IN ANY WAY WITHOUT THE WRITTEN CONSENT OF FCI CDC.

E-3005

04/14/99

K01-R65

 CDC TITLE:	Type	PRODUCT SPECIFICATION	GS-12-406	
	MicroTCA POWER I/O CONNECTOR PCB MALE CONNECTOR		PAGE	REV.
			16 of 27	A
		AUTHORIZED BY	DATE (yy/mm/dd)	
		SINESH	2007/01/10	

		Set 1 Set 2	Uncontrolled environment application: Mated Connector 5 days. NO2: 200ppb(+/-50) Cl2: 20ppb(+/-5) H2S:100ppb(+/-20) SO2: 200ppb(+/-50)	Mixed flowing Gas. Uncontrolled environment	EIA-364-65 Class IIIA	This section is applied only for uncontrolled environment application test.
A9 (Continued)	Corrosion industrial atmosphere (Continued)	Set 1	Max. voltage = 20 mV in open circuit Max. current = 100 mA	Contact Resistance	IEC 60512-2-1	This section is applied only for uncontrolled environment application test. ≤10 milli Ohms (Power) ≤25 milli Ohms (Power)
		Set 1	Disturb Module PCB slightly from Connector, and then reseal.	Minute Disturbance	GR-1217-CORE, 9.1.3.2 paragraph 7; 9.1.3.3, paragraph 7	
		Set 1	Max. voltage = 20 mV in open circuit Max. current = 100 mA	Contact Resistance	IEC 60512-2-1	≤10 milli Ohms (Power) ≤25 milli Ohms (Power)
A10	Mechanical Operation	Set 1 Set 2	Speed = 10 mm/s max. Rest 5 s (unmated) Remaining 100 operations	Post-wear	IEC 60512-5. Test 9a	

NOTE: THIS DOCUMENT IS THE PROPERTY OF AND EMBODIES PROPRIETARY INFORMATION OF THE FCI CDC COMPANY. NO PART OF THE INFORMATION SHOWN ON THIS DOCUMENT MAY BE USED IN ANY WAY WITHOUT THE WRITTEN CONSENT OF FCI CDC.

 CDC TITLE:	Type PRODUCT SPECIFICATION	GS-12-406	
	MicroTCA POWER I/O CONNECTOR PCB MALE CONNECTOR		PAGE 17 of 27
		AUTHORIZED BY SINESH	DATE (yy/mm/dd) 2007/01/10

		Set 1	Max. voltage = 20 mV in open circuit Max. current = 100 mA	Contact Resistance	IEC 60512-2-1	≤10 milli Ohms (Power) ≤25 milli Ohms (Power)
A11	Engaging/ Separating Force	Set 2	Speed = 10 mm/s max. Plug-in card insertion and extraction	Engaging and separating forces	IEC 60512-13-1	
A12	Contact normal force	Set 1		Contact force	EIA-364-04	This is for design verification purpose and no requirement. (Preferred = 0.98 N minimum)
A13	General examination	Set 1 Set 2	Unmated Connectors	Visual examination	IEC 60512-1-1	There shall be no defect that would impair normal operation

4.2.2.2 Group B - Mechanical endurance and dust :-
 **Mechanical endurance and dust testing sequence**

Test phase	Title	Specimen	Severity /Condition of test	Measurement to be performed.	Ref. Standard	Requirements
B1	General examination	Set 1 Set 2 Set 4	Unmated & un mounted connectors	Visual examination	IEC 60512-1-1	There shall be no defect that would impair normal operation.
B2	Contact normal force	Set 1		Contact Force	EIA-364-04	This is for design verification purpose and no requirement. (Preferred = 0.98 N minimum)
B3	Engaging/ Separating Force	Set 2	Speed = 10 mm/s max. Plug-in card insertion and extraction	Engaging and separating forces	IEC 60512-13-1	

NOTE: THIS DOCUMENT IS THE PROPERTY OF AND EMBODIES PROPRIETARY INFORMATION OF THE FCI CDC COMPANY. NO PART OF THE INFORMATION SHOWN ON THIS DOCUMENT MAY BE USED IN ANY WAY WITHOUT THE WRITTEN CONSENT OF FCI CDC.
 E-3005 04/14/99

 CDC TITLE:	Type	PRODUCT SPECIFICATION	GS-12-406	
	MicroTCA POWER I/O CONNECTOR PCB MALE CONNECTOR		PAGE	REV.
18 of 27			A	
AUTHORIZED BY		DATE (yy/mm/dd)		
SINESH		2007/01/10		

B4	Insulation test	Set 2	Section 7.5.3.5&Mated Condition	insulation resistance	IEC 60512-3-1	5000 MΩ initial / 500 MΩ after tests (under 1000 V)
B5	Voltage stress tests	Set 2	Section 7.5.3.2&Mated Condition	Voltage-proof	IEC 60512-4-1	1000 Vrms (There shall b no breakdown /flashover)
B6	Contact Resistance	Set 1	Max. voltage = 20 mV in open circuit Max. current = 100 mA	Contact Resistance	IEC 60512-2-1	≤10 milli Ohms (Power) ≤25 milli Ohms (Power)
B7	Mechanical Operation	Set 1 Set 2	Speed = 10 mm/s max. Rest 5 s (unmated) Initial 100 operations	Pre-wear	IEC60512-5.9a	
		Set 1	Max. voltage = 20 mV in open circuit Max. current = 100 mA	Contact resistance	IEC 60512-2-1	≤10 milli Ohms (Power) ≤25 milli Ohms (Power)
B8	Dust	Set 1 Set 4	Unmated and mounted Connectors + Module PCB's Benign dust concentration of 300 g/m ³ of chamber volume, flow rate = 300 m/s and an exposure time of 1 h. According to GR-1217-CORE, Sections 9.1.1.1 and 9.1.1.2 Recovery time 2 h	Dust exposure	EIA-364-91	
		Set 1	Max voltage = 20 mV in open circuit Max current = 100 mA	Contact resistance	IEC 60512-2-1	This section is out of GR-1217-CORE requirement, but preferred to add for tighter environment application use ≤10 milli Ohms (Power) ≤25 milli Ohms (Power)

NOTE: THIS DOCUMENT IS THE PROPERTY OF AND EMBODIES PROPRIETARY INFORMATION OF THE FCI CDC COMPANY. NO PART OF THE INFORMATION SHOWN ON THIS DOCUMENT MAY BE USED IN ANY WAY WITHOUT THE WRITTEN CONSENT OF FCI CDC.

E-3005

04/14/99

K01-R65

 CDC TITLE:	Type	PRODUCT SPECIFICATION	GS-12-406	
	MicroTCA POWER I/O CONNECTOR PCB MALE CONNECTOR		PAGE	REV.
19 of 27			A	
AUTHORIZED BY		DATE (yy/mm/dd)		
SINESH		2007/01/10		

B9	Vibration	Set 1 Set 2 Set 4 Set 5	Frequency 10 Hz to 500 Hz Amplitude 0.35 mm or 50 m/s ² Full duration 3 x 8 h in three axes (32 sweepings in each direction)	Monitored vibration	IEC 60512-6-4	
		Set 1	Max. voltage = 20 mV in open circuit Max. current = 100 mA	Contact Resistance	IEC 60512-2-1	≤10 milli Ohms (Power) ≤25 milli Ohms (Power)
B10	Shock	Set 1 Set 2 Set 4 Set 5	Shock acceleration 300 m/s ² Duration of impact 11 ms Three shocks in two directions along 3 axes (18 shocks total)	Monitored mechanical shock	IEC 60512-6-3	This section is applied only for uncontrolled environment application test.
		Set 1	Max. voltage = 20 mV in open circuit Max. current = 100 mA	Contact Resistance	IEC 60512-2-1	≤10 milli Ohms (Power) ≤25 milli Ohms (Power)
B11	Mechanical Operation	Set 1 Set 2 Set 4	Speed = 10 mm/s max. Rest 5 s (unmated) Remaining 100 operations	Post-wear	IEC 60512-5. Test 9a	
		Set 1	Max. voltage = 20 mV in open circuit Max. current = 100 mA	Contact Resistance	IEC 60512-2-1	≤10 milli Ohms (Power) ≤25 milli Ohms (Power)
B12	Engaging/ Separating Force	Set 2	Speed = 10 mm/s max. Plug-in card insertion and extraction	Engaging and separating forces	IEC 60512-13-1	
B13	Insulation test	Set 2	Section 7.5.3.5&Mated Condition	insulation resistance	IEC 60512-3-1	5000 MΩ initial / 500 MΩ after tests (under 1000 V)
B14	Voltage stress tests	Set 2	Section 7.5.3.2&Mated Condition	Voltage-proof	IEC 60512-4-1	1000 Vrms (There shall b no breakdown)

NOTE: THIS DOCUMENT IS THE PROPERTY OF AND EMBODIES PROPRIETARY INFORMATION OF THE FCI CDC COMPANY. NO PART OF THE INFORMATION SHOWN ON THIS DOCUMENT MAY BE USED IN ANY WAY WITHOUT THE WRITTEN CONSENT OF FCI CDC.

E-3005

04/14/99

K01-R65

 CDC <small>TITLE:</small>	Type	PRODUCT SPECIFICATION		GS-12-406	
	MicroTCA POWER I/O CONNECTOR PCB MALE CONNECTOR			PAGE	20 of 27
AUTHORIZED BY				SINESH	DATE (yy/mm/dd)

						/flashover)
B15	Contact normal force	Set 1		Contact force	EIA-364-04	This is for design verification purpose and no requirement. (Preferred = 0.98 N minimum)
B14	General examination	Set 1 Set 2	Unmated Connectors	Visual examination	IEC 60512-1-1	There shall be no defect that would impair normal operation

4.2.2.3 Group C - Thermal shock and moisture
 **Thermal shock and moisture testing sequence**

Test phase	Title	Specimen	Severity /Condition of test	Measurement to be performed.	Ref. Standard	Requirements
C1	General examination	Set 1 Set 2 Set 3	Unmated & un mounted connectors	Visual examination	IEC 60512-1-1	There shall be no defect that would impair normal operation.
C2	Contact normal force	Set 1		Contact Force	EIA-364-04	This is for design verification purpose and no requirement. (Preferred = 0.98 N minimum)
C3	Engaging/ Separating Force	Set 2	Speed = 10 mm/s max. Plug-in card insertion and extraction	Engaging and separating forces	IEC 60512-13-1	

NOTE: THIS DOCUMENT IS THE PROPERTY OF AND EMBODIES PROPRIETARY INFORMATION OF THE FCI CDC COMPANY. NO PART OF THE INFORMATION SHOWN ON THIS DOCUMENT MAY BE USED IN ANY WAY WITHOUT THE WRITTEN CONSENT OF FCI CDC.

	Type	PRODUCT SPECIFICATION	GS-12-406	
	MicroTCA POWER I/O CONNECTOR PCB MALE CONNECTOR		PAGE	REV.
TITLE:			21 of 27	A
		AUTHORIZED BY	DATE (yy/mm/dd)	
		SINESH	2007/01/10	

C4	Insulation test	Set 2	Section 7.5.3.5&Mated Condition	insulation resistance	IEC 60512-3-1	5000 MΩ initial / 500 MΩ after tests (under 1000 V)
C5	Voltage stress tests	Set 2	Section 7.5.3.2&Mated Condition	Voltage-proof	IEC 60512-4-1	1000 Vrms (There shall b no breakdown /flashover)
C6	Contact Resistance	Set 1	Max. voltage = 20 mV in open circuit Max. current = 100 mA	Contact Resistance	IEC 60512-2-1	≤10 milli Ohms (Power) ≤25 milli Ohms (Power)
C7	Mechanical Operation	Set 1 Set 2	Speed = 10 mm/s max. Rest 5 s (unmated) Initial 100 operations	Pre-wear	IEC60512-5.9a	
		Set 1	Max. voltage = 20 mV in open circuit Max. current = 100 mA	Contact resistance	IEC 60512-2-1	≤10 milli Ohms (Power) ≤25 milli Ohms (Power)
C8	Dust	Set 1 Set 4	Unmated and mounted Connectors + Module PCB's Benign dust concentration of 300 g/m3 of chamber volume, flow rate = 300 m/s and an exposure time of 1 h. According to GR-1217-CORE, Sections 9.1.1.1 and 9.1.1.2 Recovery time 2 h	Dust exposure	EIA-364-91	
		Set 1	Max voltage = 20 mV in open circuit Max current = 100 mA	Contact resistance	IEC 60512-2-1	This section is out of GR-1217-CORE requirement, but preferred to add for tighter environment application use ≤10 milli Ohms (Power) ≤25 milli Ohms (Power)

NOTE: THIS DOCUMENT IS THE PROPERTY OF AND EMBODIES PROPRIETARY INFORMATION OF THE FCI CDC COMPANY. NO PART OF THE INFORMATION SHOWN ON THIS DOCUMENT MAY BE USED IN ANY WAY WITHOUT THE WRITTEN CONSENT OF FCI CDC.

E-3005

04/14/99

K01-R65

 CDC TITLE:	Type	PRODUCT SPECIFICATION	GS-12-406	
	MicroTCA POWER I/O CONNECTOR PCB MALE CONNECTOR		PAGE	REV.
AUTHORIZED BY			DATE (yy/mm/dd)	
		SINESH	2007/01/10	

C9	Thermal Shock	Set 1 Set 2 Set 4	<p>Five cycles of alternating high and low temperature. 30 minutes dwell at each extreme, with a max. transfer time of 5 s between extremes.</p> <p>Central office environment application: -55 °C to 85°C According to GR-1217-CORE, Section 6.3.3, R6-57</p> <p>Uncontrolled environment application: -65 °C to 105°C According to GR-1217-CORE, Section 6.3.3, R6-58</p>	Monitored thermal shock	EIA-364-32	There shall be no contact disturbance longer than 1 µs
		Set 1	<p>Max. voltage = 20 mV in open circuit Max. current = 100 mA</p>	Contact Resistance	IEC 60512-2-1	≤10 milli Ohms (Power) ≤25 milli Ohms (Power)
C10	Damp heat, cyclic	Set 1 Set 2 Set 4	<p>Mated Connectors Central office environment application: Thermal cycling between 25 °C and 65 °C with 80% to 98% relative humidity 50 cycles, duration 500 h According to GR-1217-CORE, Section 6.3.4, R6-64</p> <p>Uncontrolled environment</p>	Temperature/ Humidity cycling	EIA-364-31	

NOTE: THIS DOCUMENT IS THE PROPERTY OF AND EMBODIES PROPRIETARY INFORMATION OF THE FCI CDC COMPANY. NO PART OF THE INFORMATION SHOWN ON THIS DOCUMENT MAY BE USED IN ANY WAY WITHOUT THE WRITTEN CONSENT OF FCI CDC.

 CDC TITLE:	Type	PRODUCT SPECIFICATION	GS-12-406	
	MicroTCA POWER I/O CONNECTOR PCB MALE CONNECTOR		PAGE	REV.
AUTHORIZED BY			DATE (yy/mm/dd)	
		SINESH	2007/01/10	

			application: Thermal cycling between 5 °C and 85 °C with 80% to 98% relative humidity 50 cycles, duration 500 h According to GR-1217- CORE, Section 6.3.4, R6-65			
		Set 1	Max. voltage = 20 mV in open circuit Max. current = 100 mA	Contact Resistance	IEC 60512- 2-1	≤10 milli Ohms (Power) ≤25 milli Ohms (Power)
C11	Engaging/ Separating Force	Set 2	Speed = 10 mm/s max. Plug-in card insertion and extraction	Engaging and separating forces	IEC 60512- 13-1	
C12	Insulation test	Set 2	Section 7.5.3.5&Mated Condition	insulation resistance	IEC 60512- 3-1	5000 MΩ initial / 500 MΩ after tests (under 1000 V)
C13	Voltage stress tests	Set 2	Section 7.5.3.2&Mated Condition	Voltage- proof	IEC 60512- 4-1	1000 Vrms (There shall b no breakdown /flashover)
C14	Contact normal force	Set 1		Contact force	EIA-364- 04	This is for design verification purpose and no requirement. (Preferred = 0.98 N minimum)
C15	General examination	Set 1 Set 2	Unmated Connectors	Visual examination	IEC 60512- 1-1	There shall be no defect that would impair normal operation

**4.2.2.3 Group D - High temperature and electrical load
High temperature and electrical load testing sequence:-**

Test phase	Title	Specimen	Severity /Condition of test	Measurement to be performed.	Ref. Standard	Requirements
------------	-------	----------	-----------------------------	------------------------------	---------------	--------------

NOTE: THIS DOCUMENT IS THE PROPERTY OF AND EMBODIES PROPRIETARY INFORMATION OF THE FCI CDC COMPANY. NO PART OF THE INFORMATION SHOWN ON THIS DOCUMENT MAY BE USED IN ANY WAY WITHOUT THE WRITTEN CONSENT OF FCI CDC.

 CDC <small>TITLE:</small>	Type	PRODUCT SPECIFICATION	GS-12-406	
	MicroTCA POWER I/O CONNECTOR PCB MALE CONNECTOR		PAGE	REV.
AUTHORIZED BY			DATE (yy/mm/dd)	
		SINESH	2007/01/10	

D1	General examination	Set 1 Set 2 Set 3	Unmated & un mounted connectors	Visual examination	IEC 60512-1-1	There shall be no defect that would impair normal operation.
D2	Contact normal force	Set 1		Contact Force	EIA-364-04	This is for design verification purpose and no requirement. (Preferred = 0.98 N minimum)
D3	Engaging/ Separating Force	Set 2	Speed = 10 mm/s max. Plug-in card insertion and extraction	Engaging and separating forces	IEC 60512-13-1	
D4	Insulation test	Set 2	Section 7.5.3.5&Mated Condition	insulation resistance	IEC 60512-3-1	5000 MΩ initial / 500 MΩ after tests (under 1000 V)
D5	Voltage stress tests	Set 2	Section 7.5.3.2&Mated Condition	Voltage-proof	IEC 60512-4-1	1000 Vrms (There shall b no breakdown /flashover)
D6	Contact Resistance	Set 1	Max. voltage = 20 mV in open circuit Max. current = 100 mA	Contact Resistance	IEC 60512-2-1	≤10 milli Ohms (Power) ≤25 milli Ohms (Power)
D7	High Temperature Life	Set 1 Set 2	Mated Connectors Ambient temperature 105° C No electrical load Duration 300 h Recovery time 2 h	Temperatur e Life	EIA-364-17	Even the central office environment application, Connectors in MicroTCA shall be tested at this temperature condition
		Set 1	Max voltage = 20 mV in open circuit Max current = 100 mA	Contact resistance	IEC 60512-2-1	≤10 milli Ohms (Power) ≤25 milli Ohms (Power)
D8	Static Load Retention	Set 2	Unmated & un mounted connectors	visual examination	IEC 60512-1-1	There shall be no damage that would impair normal operation

NOTE: THIS DOCUMENT IS THE PROPERTY OF AND EMBODIES PROPRIETARY INFORMATION OF THE FCI CDC COMPANY. NO PART OF THE INFORMATION SHOWN ON THIS DOCUMENT MAY BE USED IN ANY WAY WITHOUT THE WRITTEN CONSENT OF FCI CDC.

E-3005

04/14/99

K01-R65

 CDC TITLE:	Type PRODUCT SPECIFICATION	GS-12-406	
	MicroTCA POWER I/O CONNECTOR PCB MALE CONNECTOR		PAGE 25 of 27
AUTHORIZED BY SINESH			DATE (yy/mm/dd) 2007/01/10

D9	Engaging/ Separating Force	Set 2	Speed = 10 mm/s max. Plug-in card insertion and extraction	Engaging and separating forces	IEC 60512- 5 test9a	
D10	Insulation test	Set 2	Section 7.5.3.5&Mated Condition	insulation resistance	IEC 60512- 3-1	5000 MΩ initial / 500 MΩ after tests (under 1000 V)
D11	Voltage stress tests	Set 2	Section 7.5.3.2&Mated Condition	Voltage- proof	IEC 60512- 4-1	1000 Vrms (There shall b no breakdown /flashover)
C12	Contact normal force	Set 1		Contact force	EIA-364- 04	This is for design verification purpose and no requirement. (Preferred = 0.98 N minimum)
C13	General examination	Set 1 Set 2	Unmated Connectors	Visual examination	IEC 60512- 1-1	There shall be no defect that would impair normal operation

**4.2.2.3 Group E- Electrical load and temperature
Electrical load and temperature testing sequence:-**

Test phase	Title	Specimen	Severity /Condition of test	Measurement to be performed.	Ref. Standard	Requirments
E1	General examination	Set 3	Unmated & un mounted connectors	Visual examination	IEC 60512-1-1	There shall be no defect that would impair normal operation.
E2	Electrical load &temperature	Set 3		Current carrying capacity	IEC 60512-5-5	This is for design verification purpose and no requirement. (Preferred = 0.98 N minimum)

 CDC <small>TITLE:</small>	Type	PRODUCT SPECIFICATION		GS-12-406	
	MicroTCA POWER I/O CONNECTOR PCB MALE CONNECTOR			PAGE	REV.
				26 of 27	A
			AUTHORIZED BY	DATE (yy/mm/dd)	
			SINESH	2007/01/10	

E3	General examination	Set 3	Unmated & un mounted connectors	Visual examination	IEC 60512-1-1	There shall be no defect that would impair normal operation.
----	---------------------	-------	---------------------------------	--------------------	---------------	--

4.2 Accessories

Insert M3/4.40UNC	: Retention against torque 0.7N.m Min.
Female screw lock	: Retention against torque 0.5N.m Min.

5. Reflow process

Lead free soldering

In accordance with: JSTD_020C 5 (solder pick to 265°)

6. Packaging

Packing According to GS-14-1104 . The traceability of all parts must be guaranteed by date code on each product.

 CDC <small>TITLE:</small>	<small>Type</small> PRODUCT SPECIFICATION	GS-12-406	
	MicroTCA POWER I/O CONNECTOR PCB MALE CONNECTOR	<small>PAGE</small> 27 of 27	<small>REV.</small> A
<small>AUTHORIZED BY</small> SINESH		<small>DATE (yy/mm/dd)</small> 2007/01/10	

7.Revision record

Rev.	Page	Description	ECN	YY/MM/DD
A	All	Released	I07-0005	2007/01/10